

Pilot's Guide

RDR-1600

Color Weather and Search and Rescue Radar

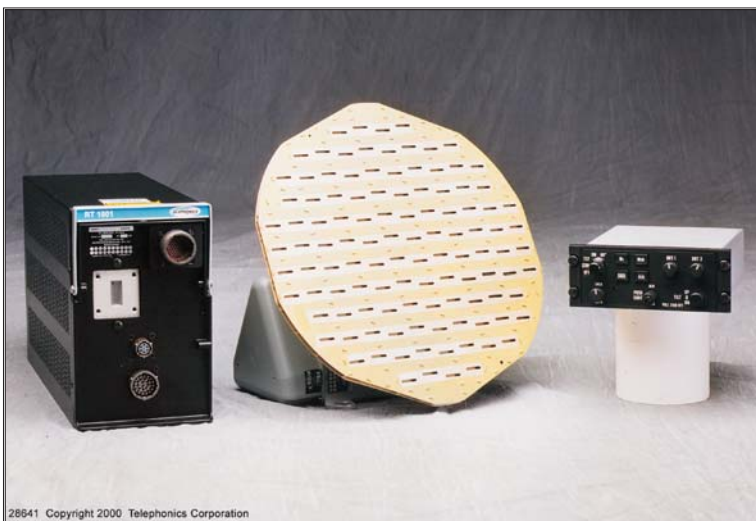

Command Systems Division

TM106101

October 2004

TABLE OF CONTENTS

<u>PARAGRAPH</u>	<u>TITLE</u>	<u>PAGE</u>
1.0	INTRODUCTION	1
1.1	ADVISORY CIRCULAR	2
1.2	SAFETY ADVISORY	11
	WARNING	13
	CAUTION	13
	MAXIMUM PERMISSIBLE EXPOSURE LEVEL (MPEL)	14
2.0	SYSTEM CONFIGURATION	15
2.1	ANTENNA AND RECEIVER-TRANSMITTER	16
2.2	RADAR DISPLAY INDICATOR	17
3.0	OPERATIONAL CONTROLS	18
3.1	FUNCTION SELECTOR – CP-113K CONTROL PANEL	18
3.2	ANTENNA CONTROLS	19
3.3	DISPLAY CONTROLS	19
3.4	PRIMARY MODE SELECTORS	19
3.5	SECONDARY MODE SELECTOR AND GAIN CONTROLS	21
3.6	ALPHANUMERICS	22
4.0	PREFLIGHT (PFT)	23
4.1	PREFLIGHT WARNING	23
5.0	THEORY OF OPERATION	24
5.1	GENERAL	24
5.2	RADAR PRINCIPLES	25
5.3	WEATHER RADAR PRINCIPLES	26
5.4	RADAR REFLECTIVITY	27
5.5	WEATHER DISPLAY CALIBRATION	28
5.6	WEATHER ATTENUATION COMPENSATION	29
6.0	WEATHER OPERATIONS	31
6.1	WEATHER MODE – WX	31
6.2	WEATHER ALERT MODE – WXA	32
6.3	TARGET ALERT	32
6.4	WEATHER MAPPING AND INTERPRETATION	33
6.5	OBSERVING WEATHER	33
6.5.1	Thunderstorms and Turbulence	34
6.5.2	Tornadoes	35
6.5.3	Hail	36
6.5.4	Icing	37
6.5.5	Snow	37
6.5.6	Lightning and Static Discharges	37

TABLE OF CONTENTS (CONT.)

<u>PARAGRAPH</u>	<u>TITLE</u>	<u>PAGE</u>
6.5.7	Range Resolution	38
6.5.8	Azimuth Resolution	38
6.5.9	Indicator Resolution	39
6.5.10	Short Range Displays	40
6.6	PATH PLANNING	41
6.6.1	Path Planning Considerations	41
7.0	SEARCH OPERATIONS	44
7.1	GROUND MAPPING	44
7.1.1	Looking Angle	45
7.1.2	Other Aircraft	46
7.2	SEARCH MODE	46
7.3	DIFFERENCE BETWEEN WEATHER AND SEARCH MODES	47
7.4	SEARCH MODES COMPARED	48
7.4.1	Search 3	48
7.4.2	Search 2	49
7.4.3	Search 1	49
8.0	TILT MANAGEMENT	50
8.1	TILT CONTROL	50
8.2	TILT PERFORMANCE CHECK	51
8.3	EARLY DETECTION OF ENROUTE WEATHER	52
9.0	ANTENNA STABILIZATION	53
9.1	LIMITS	53
9.2	ERRORS	53
9.3	COMPENSATION	54
10.0	BEACON MODES	55
10.1	BEACON FORMAT SELECTION	56
10.2	DO-172	56
11.0	AC 90-80	57
12.0	MULTIPLE INDICATORS	58
13.0	SYSTEM SPECIFICATIONS	59
13.1	RT-1601 RT UNIT	59
13.2	DA-1203A ANTENNA DRIVE ASSEMBLY	59
13.3	CP-113K CONTROL PANEL	60

LIST OF ILLUSTRATIONS

<u>FIGURE</u>	<u>TITLE</u>	<u>PAGE</u>
1.1-1	Cross-Section of a Thunderstorm	4
2-1	Typical System Block Diagram	15
2.1-1	Receiver-Transmitter	16
2.1-2	DA-1203A Drive Assembly with AA4512A 12" Flat Plate Antenna	16
2.1-3	CP-113K Control Panel	16
2.2-1	MFD Display	17
3.1-1	CP-113K Control Panel	18
3.2-1	Tilt Control	19
3.4-1	Primary Mode Selectors	20
3.5-1	Secondary Mode Selector and Gain Controls	21
3.6-1	MFD Screen Presentations	22
4.1-1	Preflight Warnings	23
5.2-1	Radar Transmit-Receive Timing	25
5.4-1	Reflective Levels	27
5.6-1	STC Electronically Compensates for Distance Attenuation	29
6.1-1	Typical Weather Display	31
6.3-1	Weather Alert with Target Alert Display	32
6.5-1	Storm Components	33
6.5.3-1	Finger	36
6.5.3-2	Hook	36
6.5.3-3	Scalloped Edge	36
6.5.3-4	U-Shaped	36
6.5.8-1	Azimuth Resolution	38
6.5.10-1	Short Range Display	40
6.6.1-1	Penetration of Weather	41
6.6.1-2	Minimizing Doglegging	42
6.6.1-3	"Blind Alley" or "Box Canyon" Situations	42
7.1-1	Over Terrain	44
7.1-2	Over Water	44
7.1.1-1	A Smaller Incident Angle	45
7.1.1-2	Concentration of the Beam	45
7.3-1	Wx and SRCH Buttons	47
7.4.1-1	Search 3	48
7.4.2-1	Search 2	49
7.4.3-1	Search 1	49

LIST OF ILLUSTRATIONS (CONT.)

<u>FIGURE</u>	<u>TITLE</u>	<u>PAGE</u>
8.1-1	Adjusting the Antenna Tilt	50
8.2-1	Altitude vs. Range	51
8.3-1	Weather Target	52
9.1-1	Aircraft Pitching/Rolling $\pm 30^\circ$	53
10.1-1	Standard Beacon	56
10.2-1	DO-172	56

LIST OF TABLES

<u>TABLE</u>	<u>TITLE</u>	<u>PAGE</u>
5.5-1	Radar Display and Thunderstorm Levels versus Rainfall Rates	28
6.5.9-1	Minimum Distinguishable Target Separation	39
8.3-1	Antenna Tilt Control Settings	52

1.0 INTRODUCTION

In the early days of aviation, pilots were more concerned with just staying airborne than worrying about weather. Airplanes were for fun. Pilots flew only short hops, on clear days, and could often see their destination. There was little need for navigation equipment. If your compass was working and your gas held out, you could probably make it home safely. Later, as flying came of age, thunderstorms and their associated turbulence were more of a problem. When the weather was good, aircraft utilization was high. But when storms were prevalent, you might take the long way home.

Today, weather radar is as much at home in the cockpit as the compass. Corporate aircraft operators, and private pilots, as well as the airlines have adopted weather radar with full confidence in its usefulness and reliability. Most commercial airborne weather radars available today also provide the pilot with one or more ancillary modes of operation and system options that make the radar more functional and increase its versatility.

Telephonics would like to welcome you to the growing family of Telephonics Weather Radar System owners and operators.

The RDR-1600 Color Weather Radar System is the newest advancement of this series of radars. The RDR-1600 series radars are the most popular, advanced capability, multi-mode radars available from any manufacturer.

The RDR-1600 provides five primary modes of operation: three air-to-surface search and detection modes, and two conventional weather avoidance modes. This lightweight digital X-band radar system provides a peak power of 10 kW, and is primarily designed for fixed or rotary-wing aircraft engaged in patrol, search and rescue missions, and for transporting personnel and equipment to remote sites (e.g., off-shore oil rigs, etc.).

The system interfaces with multi-function electronic displays. The MFD is referred to as an indicator in this manual. The RDR-1600 will also interface with an Attitude Heading Reference System (AHRS). AHRS Pitch and Roll data will be converted from digital ARINC 429 to analog pitch and roll data that is used by the DA-1203A antenna drive unit for antenna stabilization.

The RDR-1600 also has the capability to receive and decode both standard 2-pulse beacon transponders and the DO-172 6-pulse transponders. This system also provides two short ranges of 0.5 nm and 1.0 nm for search and rescue.

This manual is designed to help you understand the RDR-1600 and its operational procedures. Please read it carefully before operating the unit. If you have any questions, please contact Telephonics (see back cover).



ADVISORY CIRCULAR

DEPARTMENT OF TRANSPORTATION
Federal Aviation Administration
Washington, D.C.

Subject: THUNDERSTORMS **Date:** 1/20/83 **AC No.:** 00-24B
Initiated by: AFO-260 **Change:**

1. PURPOSE. This advisory circular describes the hazards of thunderstorms to aviation and offers guidance to help prevent accidents caused by thunderstorms.
2. CANCELLATION. Advisory Circular 00-24A, dated June 23, 1978, is canceled.
3. RELATED READING MATERIAL. Advisory Circulars 00-6A, Aviation Weather, 00-45B, Aviation Weather Services, 00-50A, Low Level Wind Shear.
4. GENERAL. We all know what a thunderstorm looks like. Much has been written about the mechanics and life cycles of thunderstorms. They have been studied for many years; and while much has been learned, the studies continue because much is not known. Knowledge and weather radar have modified our attitudes toward thunderstorms, but one rule continues to be true - any storm recognizable as a thunder-storm should be considered hazardous until measurements have shown it to be safe. That means safe for you and your aircraft. Almost any thunderstorm can spell disaster for the wrong combination of aircraft and pilot.
5. HAZARDS. A thunderstorm packs just about every weather hazard know to aviation into one vicious bundle. Although the hazards occur in numerous combinations, let us look at the most hazardous combination of thunderstorms, the squall line, then we will examine the hazards individually.
 - a. Squall Lines. A squall line is a narrow band of active thunderstorms. Often it develops on or ahead of a cold front in moist, unstable air, but it may develop in unstable air far removed from any front. The line may be too long to detour easily and too wide and severe to penetrate. It often contains steady-state thunderstorms and presents the single most intense weather hazard to aircraft. It usually forms rapidly, generally reaching maximum intensity during the late afternoon and the first few hours of darkness.

b. Tornadoes.

(1) The most violent thunderstorms draw air into their cloud bases with great vigor. If the incoming air has any initial rotating motion, it often forms an extremely concentrated vortex from the surface well into the cloud. Meteorologists have estimated that wind in such a vortex can exceed 200 knots; pressure inside the vortex is quite low. The strong winds gather dust and debris and the low pressure generates a funnel-shaped cloud extending downward from the cumulonimbus base. If the cloud does not reach the surface, it is a "funnel cloud"; if it touches a land surface, it is a "tornado."

(2) Tornadoes occur with both isolated and squall line thunderstorms. Reports for forecasts of tornadoes indicate that atmospheric conditions are favorable for violent turbulence. An aircraft entering a tornado vortex is almost certain to suffer structural damage. Since the vortex extends well into the cloud, any pilot inadvertently caught on instruments in a severe thunderstorm could encounter a hidden vortex.

(3) Families of tornadoes have been observed as appendages of the main cloud extending several miles outward from the area of lightning and precipitation. Thus, any cloud connected to a severe thunderstorm carries a threat of violence.

c. Turbulence.

(1) Potentially hazardous turbulence is present in all thunderstorms, and a severe thunderstorm can destroy an aircraft. Strongest turbulence within the cloud occurs with shear between updrafts and downdrafts. Outside the cloud, shear turbulence has been encountered several thousand feet above and 20 miles laterally from a severe storm. A low level turbulent area is the shear zone associated with the gust front. Often, a "roll cloud" on the leading edge of a storm marks the top of the eddies in this shear and it signifies an extremely turbulent zone. Gust fronts often move far ahead (up to 15 miles) of associated precipitation. The gust front causes a rapid and sometimes drastic change in surface wind ahead of an approaching storm. Advisory Circular 00-50A, "Low Level Wind Shear," explains in greater detail the hazards associated with gust fronts. Figure A-1 shows a schematic cross section of a thunderstorm with areas outside the cloud where turbulence may be encountered.

(2) It is almost impossible to hold a constant altitude in a thunderstorm, and maneuvering in an attempt to do so provides greatly increased stress on the aircraft. It is understandable that the speed of the aircraft determines the rate of turbulence encounters. Stresses are least if the aircraft is held in a constant attitude and allowed to "ride the waves." To date, we have no sure way to pick "soft spots" in a thunderstorm.

d. Icing.

(1) Updrafts in a thunderstorm support abundant liquid water with relatively large droplet sizes; and when carried above the freezing level, the water becomes supercooled. When the temperature in the upward current cools to about -15°C , much of the remaining water vapor sublimates as ice crystals; and above this level, at lower temperatures, the amount of supercooled water decreases.

(2) Supercooled water freezes on impact with an aircraft. Clear icing can occur at any altitude above the freezing level; but at high levels, icing from smaller droplets may be rime or mixed rime and clear. The abundance of large, supercooled water droplets makes clear icing very rapid between 0°C and -15°C and encounters can be frequent in a cluster of cells. Thunderstorm icing can be extremely hazardous.

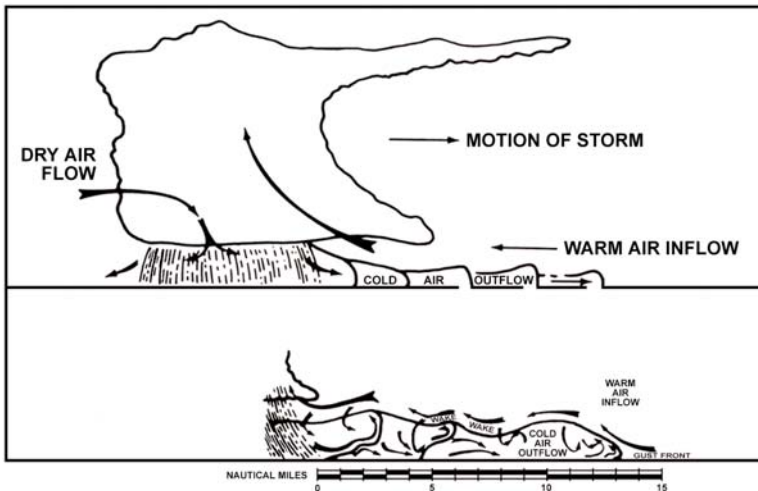

Figure 1.1-1. Cross-Section of a Thunderstorm

e. Hail.

(1) Hail competes with turbulence as the greatest thunderstorm hazard to aircraft. Supercooled drops above the freezing level begin to freeze. Once a drop has frozen, other drops latch on and freeze to it, so the hailstone grows - sometimes into a huge iceball. Large hail occurs with severe thunderstorms with strong updrafts that have built to great heights. Eventually, the hailstones fall, possibly some distance from the storm core. Hail may be encountered in clear air several miles from dark thunderstorm clouds.

AC 00-24B**1/20/83**

(2) As hailstones fall through air whose temperature is above 0°C, they begin to melt and precipitation may reach the ground as either hail or rain. Rain at the surface does not mean the absence of hail aloft. You should anticipate possible hail with any thunderstorm, especially beneath the anvil of a large cumulonimbus. Hailstones larger than one-half inch in diameter can significantly damage an aircraft in a few seconds.

f. **Low Ceiling and Visibility.** Generally, visibility is near zero within a thunderstorm cloud. Ceiling and visibility also may be restricted in precipitation and dust between the cloud base and the ground. The restrictions create the same problem as all ceiling and visibility restrictions; but the hazards are increased many fold when associated with the other thunderstorm hazards of turbulence, hail, and lightning which make precision instrument flying virtually impossible.

g. **Effect on Altimeters.** Pressure usually falls rapidly with the approach of a thunderstorm, then rises sharply with the onset of the first gust and arrival of the cold downdraft and heavy rain showers, falling back to normal as the storm moves on. This cycle of pressure change may occur in 15 minutes. If the pilot does not receive a corrected altimeter setting, the altimeter may be more than 100 feet in error.

h. **Lightning.** A lightning strike can puncture the skin of an aircraft and can damage communications and electronic navigational equipment. Lightning has been suspected of igniting fuel vapors causing explosion; however, serious accidents due to lightning strikes are extremely rare. Nearby lightning can blind the pilot rendering him momentarily unable to navigate either by instrument or by visual reference. Nearby lightning can also induce permanent errors in the magnetic compass. Lightning discharges, even distant ones, can disrupt radio communications on low and medium frequencies. Though lightning intensity and frequency have no simple relationship to other storm parameters, severe storms, as a rule, have a high frequency of lightning.

i. **Engine Water Ingestion.**

(1) Turbine engines have a limit on the amount of water they can ingest. Updrafts are present in many thunderstorms, particularly those in the developing stages. If the updraft velocity in the thunderstorm approaches or exceeds the terminal velocity of the falling raindrops, very high concentrations of water may occur. It is possible that these concentrations can be in excess of the quantity of water turbine engines are designed to ingest. Therefore, severe thunderstorms may contain areas of high water concentration which could result in flame-out and/or structural failure of one or more engines.

(2) At the present time, there is no known operational procedure that can completely eliminate the possibility of engine damage/flameout

during massive water ingestion. Although the exact mechanism of these water-induced engine stalls has not been determined, it is felt that thrust changes may have an adverse effect on engine stall margins in the presence of massive water ingestion.

(3) Avoidance of severe storm systems is the only measure assured to be effective in preventing exposure to this type of multiple engine damage/flameout. During an unavoidable encounter with severe storms with extreme precipitation, the best known recommendation is to follow the severe turbulence penetration procedure contained in the approved airplane flight manual with special emphasis on avoiding thrust changes unless excessive airspeed variations occur.

6. WEATHER RADAR.

a. Weather radar detects droplets of precipitation size. Strength of the radar return (echo) depends on drop size and number. The greater the number of drops, the stronger is the echo; and the larger the drops, the stronger is the echo. Drop size determines echo intensity to a much greater extent than does drop number. Hailstones usually are covered with a film of water and, therefore, act as huge water droplets giving the strongest of all echoes.

b. Numerous methods have been used in an attempt to categorize the intensity of a thunderstorm. To standardize thunderstorm language between weather radar operators and pilots, the use of Video Integrator Processor (VIP) levels is being promoted.

c. The National Weather Service (NWS) radar observer is able to objectively determine storm intensity levels with VIP equipment. These radar echo intensity levels are on a scale of one to six. If the maximum VIP Levels are 1 "weak" and 2 "moderate," then light to moderate turbulence is possible with lightning. VIP Level 3 is "strong" and severe turbulence is possible with lightning. VIP Level 4 is "very strong" and severe turbulence is likely with lightning. VIP Level 5 is "intense" with severe turbulence, lightning, hail likely, and organized surface wind gusts. VIP Level 6 is "extreme" with severe turbulence, lightning, large hail, extensive surface wind gusts, and turbulence.

d. Thunderstorms build and dissipate rapidly. Therefore, do not attempt to plan a course between echoes. The best use of ground radar information is to isolate general areas and coverage of echoes. You must avoid individual storms from in-flight observations either by visual sighting or by airborne radar. It is better to avoid the whole thunderstorm area than to detour around individual storms unless they are scattered.

e. Airborne weather avoidance radar is, as its name implies, for avoiding severe weather - not for penetrating it. Whether to fly into an area of

AC 00-24B**1/20/83**

radar echoes depends on echo intensity, spacing between the echoes, and the capabilities of you and your aircraft. Remember that weather radar detects only precipitation drops; it does not detect turbulence. Therefore, the radar scope provides no assurance of avoiding turbulence. The radar scope also does not provide assurance of avoiding instrument weather from clouds and fog. Your scope may be clear between intense echoes; this clear area does not necessarily mean you can fly between the storms and maintain visual sighting of them.

f. Remember that while hail always gives a radar echo, it may fall several miles from the nearest visible cloud and hazardous turbulence may extend to as much as 20 miles from the echo edge. Avoid intense or extreme level echoes by at least 20 miles; that is, such echoes should be separated by at least 40 miles before you fly between them. With weaker echoes you can reduce the distance by which you avoid them.

7. DO'S AND DON'TS OF THUNDERSTORM FLYING.

a. Above all, remember this: never regard any thunderstorm lightly even when radar observers report the echoes are of light intensity. Avoiding thunderstorms is the best policy. Following are some do's and don'ts of thunderstorm avoidance:

(1) Don't land or takeoff in the face of an approaching thunderstorm. A sudden gust front of low level turbulence could cause loss of control.

(2) Don't attempt to fly under a thunderstorm even if you can see through to the other side. Turbulence and wind shear under the storm could be disastrous.

(3) Don't fly without airborne radar into a cloud mass containing scattered embedded thunderstorms. Scattered thunderstorms not embedded usually can be visually circumnavigated.

(4) Don't trust the visual appearance to be a reliable indicator of the turbulence inside a thunderstorm.

(5) Do avoid by at least 20 miles any thunderstorm identified as severe or giving an intense radar echo. This is especially true under the anvil of a large cumulonimbus.

(6) Do circumnavigate the entire area if the area has 6/10 thunderstorm coverage.

(7) Do remember that vivid and frequent lightning indicates the probability of a severe thunderstorm.

(8) Do regard as extremely hazardous any thunderstorm with tops 35,000 feet or higher whether the top is visually sighted or determined by radar.

b. If you cannot avoid penetrating a thunderstorm, following are some do's BEFORE entering the storm:

(1) Tighten your safety belt, put on your shoulder harness if you have one, and secure all loose objects.

(2) Plan and hold your course to take you through the storm in a minimum time.

(3) To avoid the most critical icing, establish a penetration altitude below the freezing level or above the level of -15°C .

(4) Verify that pitot-heat is on and turn on carburetor heat or jet engine anti-ice. Icing can be rapid at any altitude and cause almost instantaneous power failure and/or loss of airspeed indication.

(5) Establish power settings for turbulence penetration airspeed recommended in your aircraft manual.

(6) Turn up cockpit lights to highest intensity to lessen temporary blindness from lightning.

(7) If using automatic pilot, disengage altitude hold mode and speed hold mode. The automatic altitude and speed controls will increase maneuvers of the aircraft thus increasing structural stress.

(8) If using airborne radar, tilt the antenna up and down occasionally. This will permit you to detect other thunderstorm activity at altitudes other than the one being flown.

c. Following are some do's and don'ts during the thunderstorm penetration:

(1) Do keep your eyes on your instruments. Looking outside the cockpit can increase danger of temporary blindness from lightning.

(2) Don't change power settings; maintain settings for the recommended turbulence penetration airspeed.

(3) Do maintain constant attitude; let the aircraft "ride the waves." Maneuvers in trying to maintain constant altitude increase stress on the aircraft.

(4) Don't turn back once you are in the thunderstorm. A straight course through the storm most likely will get you out of the hazards most quickly. In addition, turning maneuvers increase stress on the aircraft.



WILLIAM T. BRENNAN
Acting Director of Flight Operations

ADVISORY CIRCULAR

AC 20-68B

DEPARTMENT OF TRANSPORTATION

Federal Aviation Administration, Washington, D.C.



Recommended radiation safety precautions for ground operation of airborne weather radar.

Initiated by: AFO-512

PURPOSE

This circular sets forth recommended radiation safety precautions to be taken by personnel when operating airborne weather radar on the ground.

CANCELLATION

AC 20-68A, dated April 11, 1975, is canceled.

RELATED READING MATERIAL

- Barnes and Taylor, *Radiation Hazards and Protection* (London: George Newnes Limited, 1963), p. 211.
- U.S. Department of Health, Education and Welfare, Public Health Service, Consumer Protection and Environmental Health Service, "Environmental health microwaves, ultraviolet radiation and radiation from lasers and television receivers – An Annotated Bibliography", FS 2.300: RH-35, Washington, U.S. Government Printing Office, pp. 56-57.
- Mumford, W.W., "Some technical aspects of microwave radiation hazards", *Proceedings of the IRE*, Washington, U.S. Government Printing Office, February 1961, pp. 427-447.

BACKGROUND

Dangers from ground operation of airborne weather radar include the possibility of human body damage and ignition of combustible materials by radiated energy. Low tolerance parts of the body include the eyes and testes.

PRECAUTIONS

Management and supervisory personnel should establish procedure for advising personnel of dangers from operating airborne weather radars on the ground. Precautionary signs should be displayed in affected areas to alert personnel of ground testing.

General

- Airborne weather radar should be operated on the ground only by qualified personnel.
- Installed airborne radar should not be operated while the aircraft is in a hangar or other enclosure unless the radar transmitter is not operating, or the energy is directed toward an absorption shield which dissipates the radio frequency energy. Otherwise, radiation within the enclosure can be reflected throughout the area.

Body Damage. To prevent possible human body damage, the following precautions should be taken:

- Personnel should never stand nearby and in front of radar antenna which is transmitting. When the antenna is not scanning, the danger increases.
- A recommended safe distance from operating airborne weather radars should be established. A safe distance can be determined by using the equations in the Appendix. This criterion is now accepted by many industrial organizations and is based on limiting exposure of humans to an average power density not greater than 1 milliwatt per square centimeter.
- Personnel should be advised to avoid the end of an open wave guide unless the radar is turned off.
- Personnel should be advised to avoid looking into a wave guide, or into the open end of a coaxial connector or line connector to a radar transmitter output, as severe eye damage may result.
- Personnel should be advised that when power radar transmitters are operated out of their protective cases, X-rays may be emitted. Stray X-rays may emanate from the glass envelope-type pulsar, oscillator, clipper, or rectifier tubes, as well as magnetrons.

Combustible Materials. To prevent possible fuel ignition, an installed airborne weather radar should not be operated while an aircraft is being refueled or defueled.



M.C. Beard

Director of Airworthiness

AC 20-68B

8/8/80

1.2 SAFETY ADVISORY

SAFE DISTANCE DETERMINATION

The following information can be used in establishing a minimum safe distance from the antenna for personnel near an operating airborne weather radar.

NEAR FIELD/FAR FIELD INTERSECTION

The distance to the near field/far field intersection can be computed by:

$$R_i = \frac{G\lambda}{8\pi}$$

where R_i = intersection distance from the antenna (in meters)
 = Wave length (in meters)
 = Antenna gain

DISTANCE TO 1 MW/CM² SAFE LIMIT

For a far field power density of 1 mw/cm², the distance (in meters) from the antenna may be calculated by:

$$R_s = \sqrt{\frac{GP}{40\pi}}$$

where R_s = the minimum safe distance in meters.
 P = Transmitted average power in watts.
 G = Antenna gain

PROCEDURES

The above formulas may be used to determine the minimum safe distance. In either case, the following procedures apply:

- a. Determine the distance (R_i) to the near field/far field intersection (paragraph 1)
- b. Determine the distance (R_s) to 1 mw/cm² power density
- c. If the distance (R_s) determined in item b is less than (R_i) found in item a, use distance (R_i) as the minimum safe distance
- d. If the distance (R_s) determined in item b is greater than (R_i) found in item a, use distance (R_s) as the minimum safe distance

EXAMPLE

The following is typical data for the airborne weather radar.

Antenna Diameter: 18 inches = 45.6 cm

Transmitter Frequency: 9375 +30 MHz

Wave Length: 3.2 cm

Pulse Length: 2.5 microseconds (search)

Pulse Repetition: 200 Hz

Peak Power: 10 kilowatts

Average Power: 5 watts (search)

Antenna Gain: 1250 (31 dB)

Calculations

(1) Distance (Ri) to the near field/far field intersection

$$R_i = \frac{G\lambda}{8\pi}$$

$$R_i = \frac{(1250 \times 0.032)}{8\pi}$$

$$= 1.6 \text{ meters} = 5.25 \text{ feet}$$

(2) Distance (Rs) to 1 mw/cm² safe limit

$$R_s = \sqrt{\frac{GP}{40\pi}}$$

$$= \sqrt{\frac{(1250)(5)}{40\pi}}$$

$$= 7.05 \text{ meters} = 23.1 \text{ feet}$$

The distance (Rs) is greater than (Ri), therefore, the minimum safe distance is 23.1 feet.



Radiation

WARNING

**This instrument generates microwave radiation.
DO NOT OPERATE UNTIL YOU HAVE READ
AND CAREFULLY FOLLOWED ALL SAFETY
PRECAUTIONS AND INSTRUCTIONS IN
THE OPERATING AND SERVICE MANUALS.**

**IMPROPER USE OR EXPOSURE MAY CAUSE
SERIOUS BODILY INJURY**

CAUTION

Maintain prescribed safe distance when standing in front of radiating antenna.

Never expose eyes or any part of the body to an unterminated wave guide.

MAXIMUM PERMISSIBLE EXPOSURE LEVEL (MPEL)

In order to avoid the envelope in which the radiation level exceeds the U.S. Government standard of 1 mW per square centimeter, all personnel should remain beyond the distance indicated in the illustration below. The distance to the MPEL boundary is calculated upon the basis of the largest antenna available with the RDR-1600 system, rated output power of the transmitter and in the non-rotating or boresight position of the antenna. With a scanning beam, the power density at the MPEL boundary is significantly reduced.

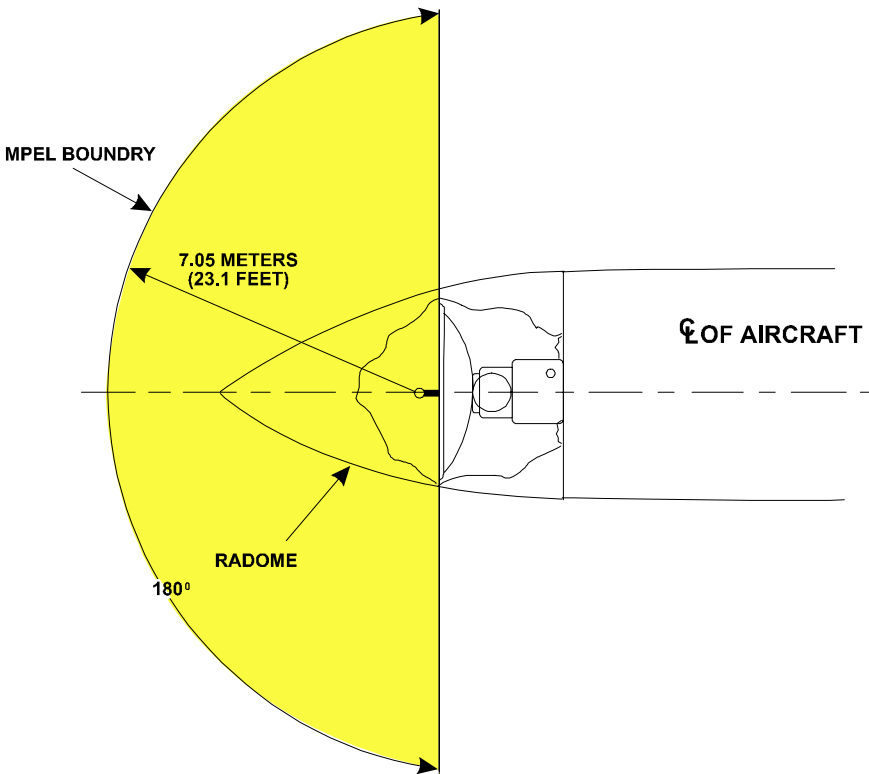

2.0 SYSTEM CONFIGURATION

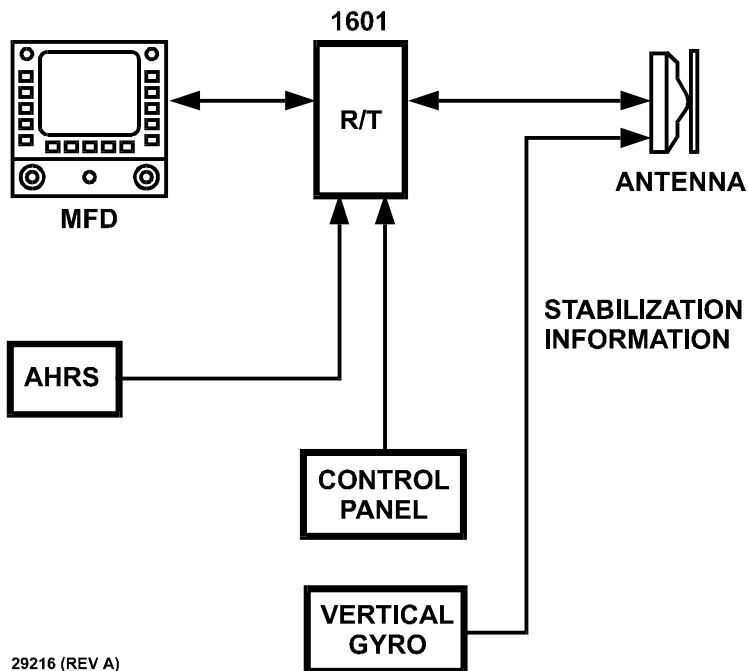

Figure 2-1. Typical System Block Diagram

2.1 ANTENNA AND RECEIVER-TRANSMITTER

The RT-1601 Receiver-Transmitter generates 10 KW pulses of X-band energy. Reflected signals of weather, search and beacon modes received by the antenna are amplified and sent to the radar display indicator.

The flat-panel antenna, which is available in diameters of 10, 12 or 18 inches scans 60 or 120 degrees. Swept by a motor-driven gear train, the vertical component is positioned by the tilt control on the Radar Control Panel (RCP or CP-113k). A stabilization system presents an upright radar display while the aircraft is turning, climbing or descending.



Figure 2.1-1. Receiver-Transmitter



Figure 2.1-2. DA-1203A Drive Assembly with AA4512A 12" Flat Plate Antenna



Figure 2.1-3. CP-113K Control Panel

2.2 RADAR DISPLAY INDICATOR

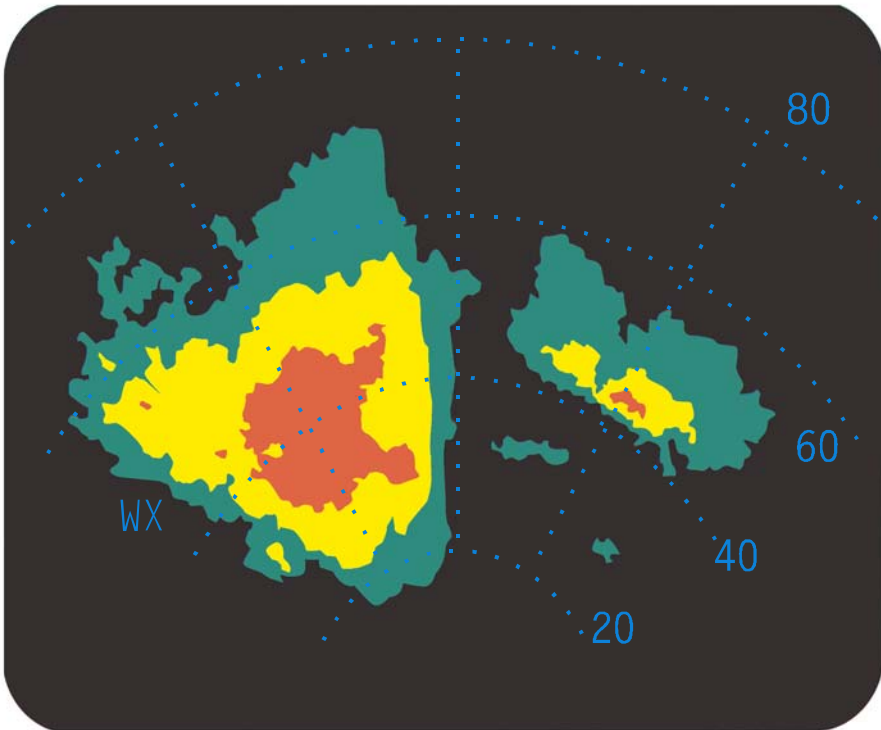

Figure 2.2-1. MFD Display

The MFD displays green, yellow and red moving maps of weather and surface features.

Rainfall per hour	Ground Return	Color
0-1 mm	No significant return	Dark
1-4 mm	Light	Green
1-12 mm	Medium	Yellow
12 mm or more	Heavy	Red

The choice of two weather modes, three search modes and antenna scan of 60 or 120 degrees is selected by the pilot. A target alert feature is active in the weather alert mode, and a movable track cursor helps the pilot plan his flight around severe weather. A beacon mode enables the display of beacon locations and a code feature identifies the beacons. Beacon Formatting allows for the display of either standard or DO-172 type beacons. This information can be displayed in any of eight separate ranges.

3.0 OPERATIONAL CONTROLS

3.1 FUNCTION SELECTOR – CP-113K CONTROL PANEL

- OFF Removes system power.
- STBY System is operationally ready; no display.
- TEST Displays a test pattern without transmitting, identified by TEST and RT FAULT.
- ON System transmits in normal operation.
- 60° Directs the antenna to sector scan 60° about the boresight of the aircraft. This position will work in weather, search (map), and beacon modes.



Figure 3.1-1. CP-113K Control Panel

3.2 ANTENNA CONTROLS

- PULL STAB OFF** This switch is connected to the Tilt Control Knob. When the Tilt Control Knob is pressed in, the stabilization function is active. When this knob is pulled out, the stabilization function is turned off.
- TILT** Adjusts antenna tilt angle.

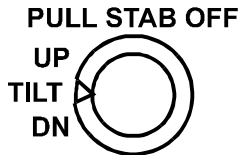

29242

Figure 3.2-1. Tilt Control

3.3 DISPLAY CONTROLS

- Display Brightness** The brightness of the display is controlled by the MFD. Refer to the MFD Pilot's Guide for operation of the display's brightness control.
- Range Up and Down** The range controls of the RDR-1600 radar system can be either on some versions of the CP-113 Radar Control Panel or on the MFD Control Panel. If the range is not on the CP-113 Radar Control Panel, then refer to the MFD Pilot's Guide for operation of the radar's range.
- The Range Up and Down buttons are used to increase or decrease the selected range. The following are valid ranges for the RDR-1600 radar system: 0.5, 1, 2, 5, 10, 20, 40, 80, 160 nm.

3.4 PRIMARY MODE SELECTORS

(PUSH ON/PUSH OFF)

- Wx** Selects weather mode, the primary mode of operation (automatically selected at turn-on). Weather displayed and Wx appear on screen. When pressed again, the weather mode is removed. If no other mode button is active, the Wx mode remains.

WxA Selects weather alert mode causing red returns to flash if the MFD is capable of performing this function. WxA appears and Target Alert is enabled.

SRCH Pressing this push button selects the three Search modes in sequential cyclic manner (i.e., Search 1, Search 2, Search 3, Search 1, Search 2, Search 3, etc.). Search modes are as follows:

Search 1 – Sea clutter rejection. Active on the ten-mile range or less.

Search 2 – Short range precision mapping. Active on the ten-mile range or less.

Search 3 – Normal surface mapping.

Beacon mode is compatible with both weather mode and Search mode. BCN

Pressing this button will select the two Beacon type formats to be selected. Sequentially pressing the Beacon button will select the following beacon modes:

Beacon Only Mode

Beacon A, Beacon B, Beacon A, Beacon B, . . .

Dual Mode (Beacon/Weather or Beacon/Search)

Beacon A, Beacon B, Beacon Off, Beacon Am . . .

Beacon Only Mode: If the starting mode of operation is weather (or search), then pressing the beacon button will place the system in Beacon/Weather (Search) mode. To activate beacon only mode, press the weather (or search) button to turn off weather (search) mode. To reactivate dual mode, press either the weather or search buttons.

Beacon A – Standard 2-pulse beacon

Beacon B – DO-172 compatible beacon

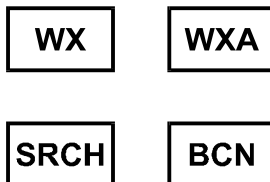

Figure 3.4-1. Primary Mode Selectors

3.5 SECONDARY MODE SELECTOR AND GAIN CONTROLS

- BCN GAIN** The Beacon Gain is a rotary potentiometer that controls the gain of the Beacon receiver.
- SRCH GAIN** The Search Gain is a rotary potentiometer that controls the gain of the Search receiver.
- CODE** Pressing this switch selects Beacon Codes in a sequential cyclic fashion (i.e., Code 0, Code 1, Code 2, . . . Code 15 or Code 0, Code 1, Code 2, . . . Code 9) depending on Beacon Mode selected. The selected code is annunciated on the MFD.

When DO-172 Beacon (Beacon Mode B) is selected via the BCN button, the total of sixteen codes (0-15) can be selected by the Code switch. Selecting a Standard two-pulse Beacon (Beacon Mode A) via the BCN button, the total of ten codes (0-9) can be selected by the Code button. The Code button is not active unless the Beacon mode has been selected.



Figure 3.5-1. Secondary Mode Selector and Gain Controls

3.6 ALPHANUMERICS

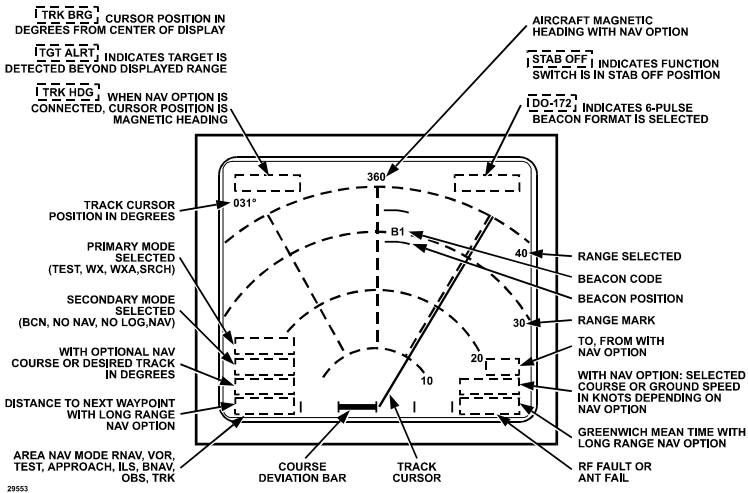

Figure 3.6-1. MFD Screen Presentations

Note

MFDs display of radar data will vary by manufacturer. Refer to the MFD Pilot's Guide for specific radar display.

4.0 PREFLIGHT (PFT)

4.1 PREFLIGHT WARNING

Test the system to verify proper operation before each flight. Rotate the function selector from OFF to STBY. Allow system to warm up for about 100 seconds, then move the function selector to TEST. No display appears in the STBY position and the radar does not transmit in either STBY or TEST. The test pattern scans 120° and automatically selects the 80 mile range. Look for distinct color bands and range marks in the order shown. Adjust display brightness for a comfortable level. Checklist and flight log options may be used at this time if installed.

WARNING

Do not turn the radar on within 25 feet of ground personnel or containers holding flammable or explosive material. The radar should never be operated during refueling.

When ready to use the radar, rotate the function selector to ON position.

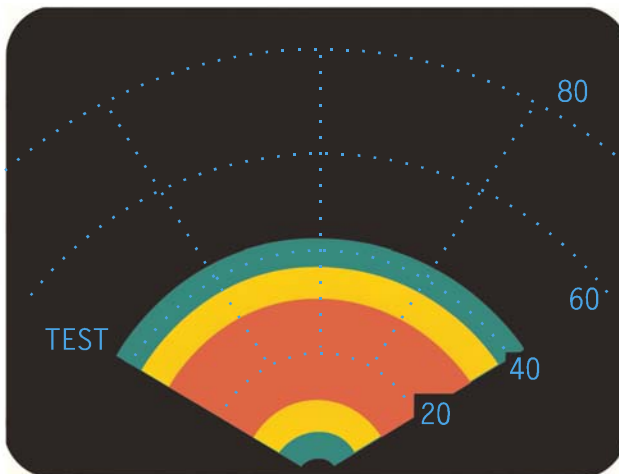

Figure 4.1-1. Preflight Warnings

Note

- ✎ The design of the system is such that full operation is possible approximately two minutes after turn-on. Therefore, the pilot may choose to leave the function switch in OFF, rather than STBY, if no significant weather is in the immediate area of the aircraft. The life of the magnetron transmitting tube will be extended by leaving the system "OFF" when possible. This, in turn, will reduce the cost of maintenance.

5.0 THEORY OF OPERATION

5.1 GENERAL

The primary use of this radar is to aid the pilot in avoiding thunderstorms and associated turbulence. Since each operator normally develops unique operational procedures for use of Weather Radar, the following information is presented for use at the operator's discretion.

Operational techniques with the RDR-1600 Series Weather Radars are not different than with earlier generation radars. The proficient operator manages his antenna tilt control to achieve the best possible knowledge of storm height, size, and relative direction of movement.

5.2 RADAR PRINCIPLES

Radar is fundamentally a distance measuring system using the principle of radio echoing. The term RADAR is an acronym for Radio Detecting And Ranging. It is a method for locating targets by using radio waves. The transmitter generates microwave energy in the form of pulses. These pulses are then transferred to the antenna where they are focused into a beam by the antenna. The radar beam is much like the beam of a flashlight. The energy is focused and radiated by the antenna in such a way that it is most intense in the center of the beam with decreasing intensity near the edge. The same antenna is used for both transmitting and receiving. When a pulse intercepts a target, the energy is reflected as an echo, or return signal, back to the antenna. From the antenna, the returned signal is transferred to the receiver and processing circuits located in the receiver transmitter unit. The echoes or returned signals are displayed on an indicator.

Radio waves travel at the speed of 300 million meters per second and thus yield nearly instantaneous information when echoing back. Radar ranging is a two-way process that requires 12.36 micro-seconds for the radio wave to travel out and back for each nautical mile of target range. As shown in the distance illustration in Figure 5.2-1, it takes 123.6 micro-seconds for a transmitted pulse of radar energy to travel out and back from an area of precipitation 10 nautical miles away.

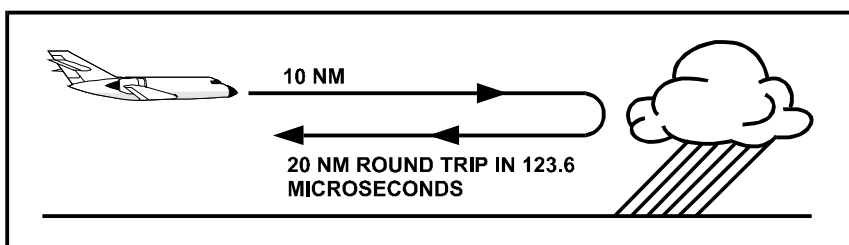

29220

Figure 5.2-1. Radar Transmit-Receive Timing

5.3 WEATHER RADAR PRINCIPLES

Airborne weather avoidance radar, as its name implies, is for avoiding severe weather – not for penetrating it. Whether to fly into an area of radar echoes depends on echo intensity, spacing between the echoes, and the capabilities of both pilot and aircraft. Remember that weather radar detects only precipitation drops; it does not detect minute cloud droplets. Therefore, the radar scope provides no assurance of avoiding instrument weather in clouds and fog. Your indicator may be clear between intense echoes; this clear area does not necessarily mean you can fly between the storms and maintain visual sighting of them.

The geometry of the weather radar radiated beam precludes its use for reliable proximity warning or anti-collision protection. The beam is characterized as a cone-shaped pencil beam. It is much like that of a flashlight or spotlight beam. It would be an event of chance, not of certainty, that such a beam would come upon another aircraft in flight.

WARNING

Weather radar is not practical as a pilot operable collision avoidance system. Weather analysis and avoidance are the primary functions of the radar system.

5.4 RADAR REFLECTIVITY

What target will reflect the radar's pulses and thus be displayed on the indicator?

Only precipitation (or objects more dense than water such as earth or solid structures) will be detected by an X-band weather radar. Therefore, weather radar does not detect clouds, thunderstorms or turbulence directly. Instead, it detects precipitation which may be associated with dangerous thunderstorms and turbulence. The best radar reflectors are raindrops and wet hail. The larger the raindrop, the better it reflects. Because large drops in a small concentrated area are characteristic of a severe thunderstorm, the radar displays the storm as a strong echo. Drop size is the most important factor in high radar reflectivity. Generally, ice, dry snow and dry hail have low reflective levels and often will not be displayed by the radar.

A cloud that contains only small raindrops, such a fog or drizzle, will not produce a measurable radar echo. But if the conditions should change and the cloud begins to produce rain, it will be displayed on radar.

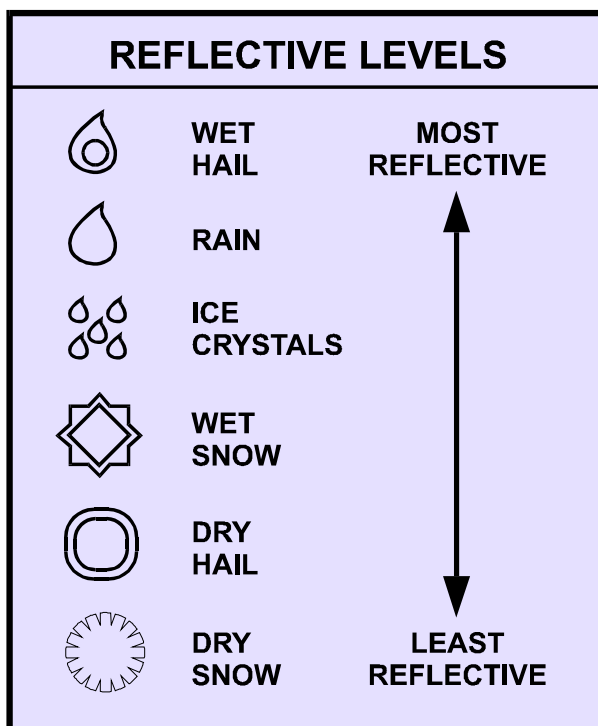

29221

Figure 5.4-1. Reflective Levels

5.5 WEATHER DISPLAY CALIBRATION

The MFD Radar display should be calibrated to show four levels of target intensity: Black (level 0), Green (level one), Yellow (level two) and Red (level three). The meaning of these levels is shown in the following chart as is their approximate relationship to the Video Integrated Processor (VIP) intensity levels used by the National Weather Service (NWS). These levels are valid only when (1) the Wx or WxA modes are selected; (2) the displayed returns are within the STC range of the radar (approximately 40 miles); (3) the returns are beam filling; and (4) there are no intervening radar returns.

Table 5.5-1. Radar Display and Thunderstorm Levels versus Rainfall Rates

Display Level	Rainfall Rate		Video Integrated Processor (VIP) Categorizations				Remarks
			Story Category	VIP Level	Rainfall Rate		
	mm/Hr.	In./Hr			mm/Hr.	In./Hr.	
3 (Red)	12	0.5	Strong	3	Greater than 12	Greater than 0.5	Severe turbulence, possible lightning
2 (Yellow)	4-12	0.17-0.5	Moderate	2	2.5-12	0.1-0.5	Light to moderate turbulence is possible with lightning
1 (Green)	1-4	0.04-0.17	Weak	1	0.25-2.5	.01-0.1	Light to moderate turbulence is possible with lightning
0 (Black)	Less than 1	Less than 0.04					

5.6 WEATHER ATTENUATION COMPENSATION

Attenuation is an extremely important phenomenon for the weather radar operator to understand. When a radar pulse is transmitted into the atmosphere, it is progressively absorbed and scattered so that it loses its ability to return to the antenna. This attenuation or weakening of the radar pulse is caused by two primary sources, distance and precipitation. The RDR-1600 radars have several advanced features which significantly reduce the affects of attenuation but no airborne weather radar can eliminate them completely. It is therefore up to the operator to understand the radar's limitations in dealing with attenuation.

Attenuation because of distance is due to the fact that the radar energy leaving the antenna is inversely proportional to the square of the distance. For example, the reflected radar energy from a target 60 miles away will be one fourth (if the target is beam filling) of the reflected energy from an equivalent target 30 miles away. The displayed effect to the operator is that as the storm is approached it will appear to be gaining in intensity. To compensate for distance attenuation, both Sensitivity Timing Control (STC) and Extended STC circuitry are employed. The RDR-1600 has an STC range of approximately 40 nautical miles and within this range the radar will electronically compensate for the effects of distance attenuation with the net effect that targets do not appear to grow larger as the distance decreases.

Outside the STC range the Extended STC circuitry increases the displayed intensity to more accurately represent storm intensity. The Extended STC will not, however, totally compensate for distance attenuation and, therefore, targets in this range can be expected to grow as the distance decreases until reaching the STC range.

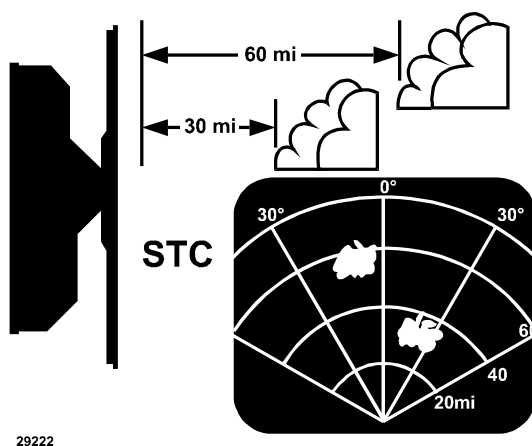

Figure 5.6-1. STC Electronically Compensates for Distance Attenuation

Attenuation due to precipitation is far more intense and is less predictable than attenuation due to distance. As the radar pulses pass through moisture, some radar energy is reflected, however, much of that energy is absorbed. If the rain is very heavy or extends for many miles, the beam may not reach completely through the area of precipitation. The weather radar has no way of knowing if the beam has been fully attenuated or has reached the far side of the precipitation area. If the beam has been fully attenuated, the radar will display a "radar shadow" which appears as an end to the precipitation when, in fact, the heavy rain may extend for many more miles. In the worst case, precipitation attenuation may cause the area of heaviest precipitation to be displayed as the thinnest area of heavy precipitation. Or it may cause one cell containing heavy precipitation to totally block or shadow a second heavy cell located behind the first cell and prevent it from being displayed on the radar.

CAUTION

Never fly into radar shadows and never believe that the full extent of heavy rain is being seen on radar unless another cell or a ground target can be seen beyond the heavy cell.

Proper use of the antenna tilt control can help detect radar shadows. Attenuation can also be a problem when flying in a large area of general rain. If the rain is moderate, the radar beam may only reach 20 or 30 miles before it is fully attenuated. The pilot may fly along for many miles seeing the same 20-30 miles of precipitation ahead on the radar when, actually, the rain may extend for a great distance. In order to aid in reducing the effects of precipitation attenuation, the RDR-1600 contains sophisticated weather attenuation compensation circuitry. The Attenuation Compensation feature is totally automatic and requires no pilot action to activate it. However, the Compensation logic cannot operate until echoes are within the Sensitivity Time Control range of approximately 40 miles. Whenever a level two (yellow) or level three (red) echo is displayed within the STC range, the Compensation circuits cause the receiver gain to increase while the antenna scans the sector containing heavy rain. The Compensation circuitry allows the radar beam to effectively look deeper into and through heavy rain to search for possible storm cells beyond. While Attenuation Compensation does not eliminate precipitation attenuation, it does allow the radar to see through more rain at short ranges where every bit of weather information possible is needed. If there is suspicion that the radar is attenuating due to precipitation, exercise extreme caution and ask the ATC Controller what they are showing. Often the ground-based ATC radar will have a better overall picture of a large rain area and the pilot can compare the controller's information with his own radar picture to avoid the strongest cells in a general area of rain.

6.0 WEATHER OPERATIONS

6.1 WEATHER MODE – WX

The RDR-1600 will provide you with target information to a greater degree than ever possible on previous generation weather radars. With a 240 nm maximum display range, you will have plenty of time to plan weather avoidance maneuvers.

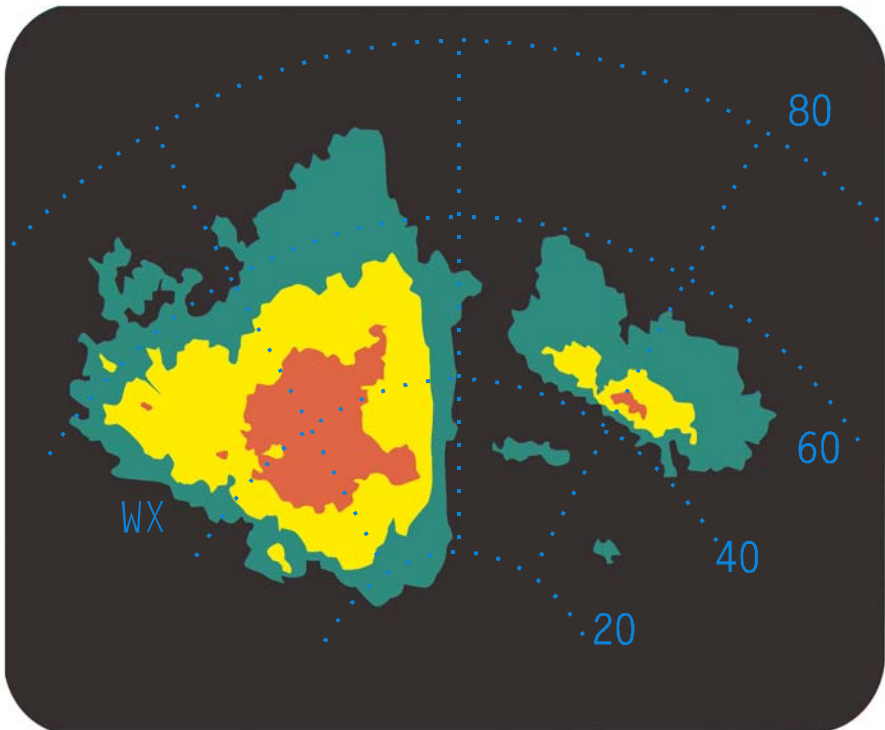

29223

Figure 6.1-1. Typical Weather Display

By pressing the “WX” button on the face of the indicator, you will see a standard weather presentation. Different levels of precipitation are displayed in Green, Yellow and Red. Use the range up/down buttons to select the desired full scale range distance to be displayed. See Paragraph 8.0 for proper Tilt Management procedures.

6.2 WEATHER ALERT MODE – WXA

In Weather Alert mode, WxA, you will see a standard weather presentation displayed in Green, Yellow and Red, except that the red returns flash between black and red to draw your attention to the heavier activity.

6.3 TARGET ALERT

In Weather Alert Mode, WxA, the words TGT ALRT flash if red returns exist within 25 miles beyond the displayed range.

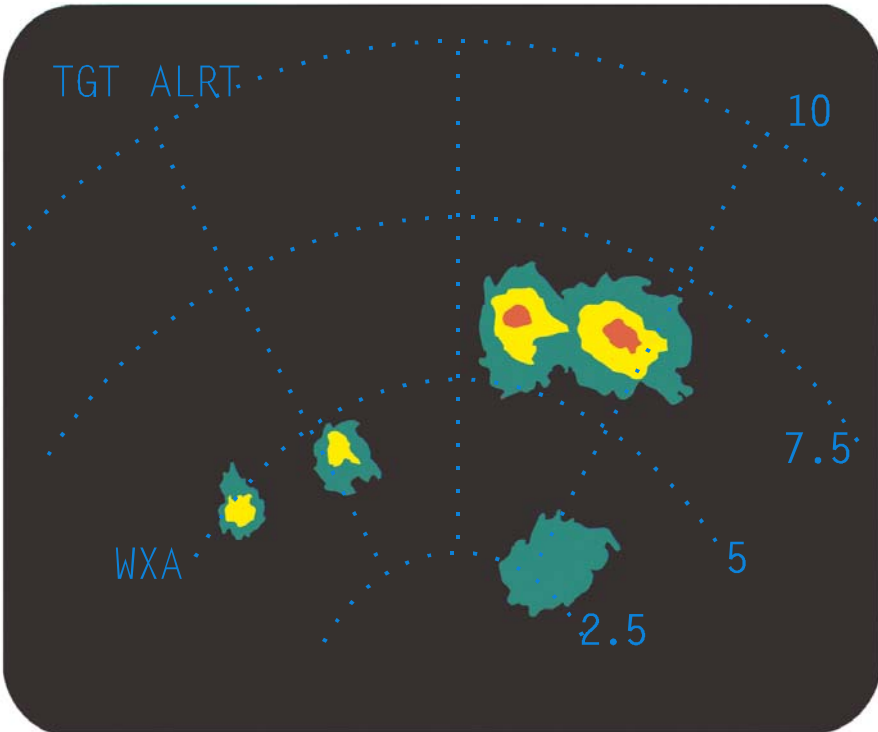

Figure 6.3-1. Weather Alert with Target Alert Display

6.4 WEATHER MAPPING AND INTERPRETATION

This section contains general information on use of the radar for weather interpretation. Review of this information will assist the pilot.

6.5 OBSERVING WEATHER

A weather radar is only as good as the operator's interpretation of the echoes that are displayed on the radar indicator. The pilot must combine his knowledge of how radar works and its limitations with such things as the prevailing weather pattern, the geographic location, and his personal experience in order to make a sound interpretation of the displayed targets.

As a starting point, the operator should read FAA Advisory Circular number 00-24B, Subject: Thunderstorms. It is also highly recommended that the operator take advantage of one of the commercially available weather radar seminars.

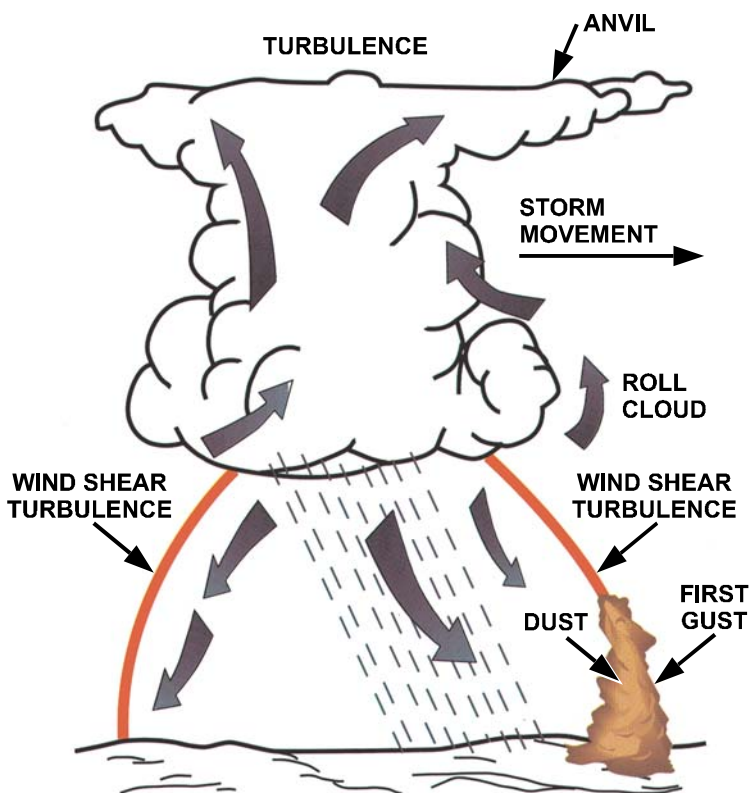

29225

Figure 6.5-1. Storm Components

6.5.1 Thunderstorms and Turbulence

The RDR-1600 weather radar can give you a clue to the presence of turbulence. Areas of the display where the colors change rapidly over a short distance represent steep rainfall gradients, which are usually associated with severe turbulence.

Turbulence may be divided into two basic types:

- (1) clear-air turbulence. It is not possible to detect clear-air turbulence with this type of radar.
- (2) turbulence associated with thunderstorms and precipitation. This type is most common. Weather radar is most helpful to the pilot with this type.

Weather guidance is now available from ground radar stations in some areas. However, this system suffers in comparison with the airborne weather radar when the weather is clearly visible on the pilot's indicator, instantly available for the pilot to act upon, considering his immediate circumstances and future flight planning.

The strong up and down drafts in a thunderstorm create very large raindrops which are usually displayed on a radar as level three.

The probability of turbulence in these strong vertical gusts is great. The National Severe Storms Laboratory (NSSL) has found that the intensity level of the precipitation reflection correlates with the degree of turbulence found in a thunderstorm. The most severe turbulence in the storm, however, may not be at the same place that gives the greatest radar reflectivity.

The rate of change in rainfall rate laterally within a storm is called the rain gradient. This change will appear on the indicator as a change from green to yellow to red. If the rainfall rate increases from level one to three in a short distance, the rain gradient is steep and severe turbulence is often present. Avoid any storm with a steep rain gradient by an extra margin and especially avoid flying near the portion of the storm with the steepest gradient.

6.5.2 Tornadoes

It is possible that conclusive methods of detecting tornadoes with airborne radar may eventually be developed. However, evidence collected to date indicates tornadoes may be detected if the following echoes are observed:

1. A hook-shaped pendant which may be 5 or more miles long and in the general shape of the numeral 6 strongly suggests the presence of a major tornado, especially if the pendant is a bright one and if it projects from the southwest quadrant (northeast quadrant in the southern hemisphere) of a major thunderstorm moving eastward. The pendant may be lost in ground clutter when viewed on the indicator and in some cases might not be much more than a blunt projection or scalloped edge of the parent thunderstorm echo.
2. A crescent-shaped indentation on the side of a major thunderstorm echo 3 to 7 miles long is another possible identifier of an active or potential tornado in the vicinity.
3. The best procedure is to make wider than usual detours around sharp-edged thunderstorms and especially those which show projections or crescent-shaped indentations.

6.5.3 Hail

Hail usually has a film of water on its surface; consequently, a hailstone is often reflected as a very large water particle. Because of the film and because hail stones usually are larger than raindrops, thunderstorms with large amounts of wet hail return stronger signals than those with rain. Although wet hail is an excellent reflector of radar energy, some hail shafts are extremely small (100 yards or less). These narrow shafts make poor radar targets.

Hail shafts are usually identified with four different characteristics patterns: (1) fingers and protrusions, (2) hooks, (3) scalloped edges on the cloud outline and (4) U-shaped cloud edges 3 to 7 miles across.

These echoes appear quite suddenly and along any edge of the storm outline. They also change in intensity and shape in a matter of seconds, and for this reason careful monitoring of the display is essential. It must be noted that weak or fuzzy projections are not normally associated with hail; however, such echoes should be watched closely for signs of rapid intensification.

The 40-mile operating range seems best and, with occasional up-tilt to check for fresh hail from above, generally good results can be obtained.

Note

It takes an experienced eye to identify “hooks” and “fingers” and other radar echo characteristics which can indicate hail or tornadoes. However, the pilot can be sure that any echo with very ragged edges or rapid changes in shape or intensity will contain severe turbulence.

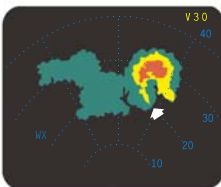

Figure 6.5.3-1. Finger

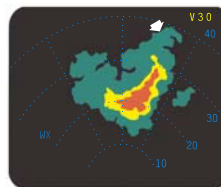

Figure 6.5.3-2. Hook

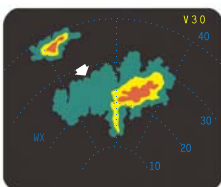

Figure 6.5.3.3. Scalloped Edge

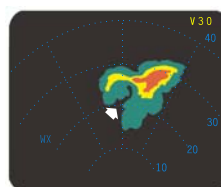

Figure 6.5.3-4. U-Shaped Edge

6.5.4 Icing

There is reason to believe that the radar will be of assistance in locating areas of heavy icing conditions. However, weather radar has not yet proved its ability to distinguish between super-cooled water droplets and ice crystals, since both are usually quite small. Needless to say, the operational problem in each case would be different. In the first case icing would definitely exist but in the second case the pure crystals would offer no danger.

1. It should be remembered, however, that super-cooled water and ice crystals can co-exist. In each case the radar echo would be small or even nil due to the minute size of the free water particles. At this time, it appears fairly certain that radar is not going to give warning of cloud icing unless it happens to be involved with active precipitation at the time. When precipitation is occurring, however, the areas of maximum ice exposure should appear as sandy or grainy echoes.
2. An icing condition that the radar might possibly detect is the intermittent moderate or heavy icing condition associated with unstable air lifted by frontal action or orographic effects. In this situation, the cumulus cells are hidden by surrounding cloud layers but could be spotted by radar. This would be of assistance in avoiding the moderate-to-heavy icing which occasionally occurs in cumulus clouds.

WARNING

Thunderstorm icing can be extremely hazardous.

6.5.5 Snow

Dry snowfall has not been detected with any success on weather radar. However, a characteristic sandy or grainy echo identifies the presence of steady moderate-to-heavy wet snow. Such echoes are not readily obvious and require a little study of the display before they can be seen.

6.5.6 Lightning and Static Discharges

Lightning and static discharges could scatter the display momentarily. However, the general presentation is unaffected and should return to normal within 1 scan.

6.5.7 Range Resolution

The ability of the radar system to resolve closely spaced targets in range depends on transmitter pulse width. In long range modes, the RDR-1600 can distinguish objects spaced as close as 0.19 nm (385 yds.) apart. In Search 1 (SR1) and Search 2 (SR2) modes on ranges of 20 miles and below, the resolution is improved to 0.04 nm (80 yds.).

6.5.8 Azimuth Resolution

The ability of the radar to resolve adjacent targets in azimuth depends on antenna beam width and range to the target. The diameter of the radiated beam increases as it gets further from the antenna. Larger antennas have narrower beam widths and, therefore, produce better ground mapping and weather pictures.

Targets separated by a distance less than the beam diameter will merge and appear on the indicator as one.

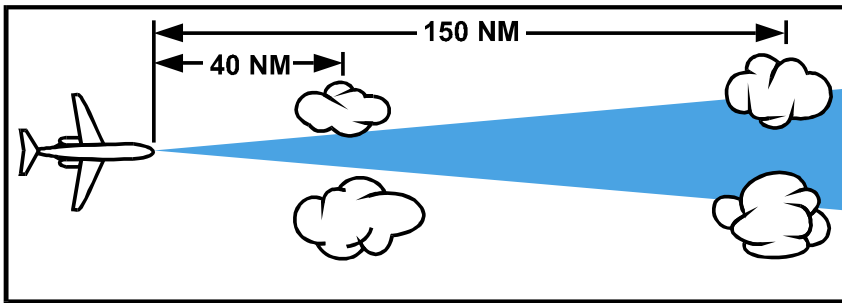

ANTENNA SIZE	BEAM WIDTH	BEAM DIAMETER (NM)			
		25 NM	50 NM	100 NM	200 NM
10"	10.0°	4	8	16	32
12"	8.0°	3	6	12	24
18"	5.5°	2	4	8	16

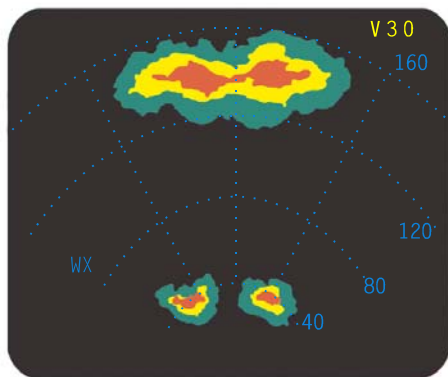

Figure 6.5.8-1. Azimuth Resolution

6.5.9 Indicator Resolution

The resolution of the indicator depends on the number of display bits on the screen. A typical screen matrix is composed of 256 bits horizontally by 256 bits vertically. The display resolution is equal to 1/256 times the display range as shown in Table 6.5.9-1. The lower the range, the better the resolution.

Table 6.5.9-1. Minimum Distinguishable Target Separation

Range (nm)	Resolution		
	Miles	Feet	Meters
2.0	0.008	48	14.8
5.0	0.02	122	37.0
10.0	0.04	243	74.1
20.0	0.08	486	148.2
40.0	0.16	972	296.3
80.0	0.31	1884	574.1

6.5.10 Short Range Displays

The RDR-1600 allows the selection of full-scale ranges of 1.0 nm and 0.5 nm in Search Modes.

These unique short range selections are especially useful during approaches and surveillance operations, because it keeps the target from getting lost in the clutter at the vertex of the display.

When operating in either short range mode, certain features become unavailable. They are: Moving Map with Waypoints, BeaconTrac and Beacon Identification. All other modes are still accessible.

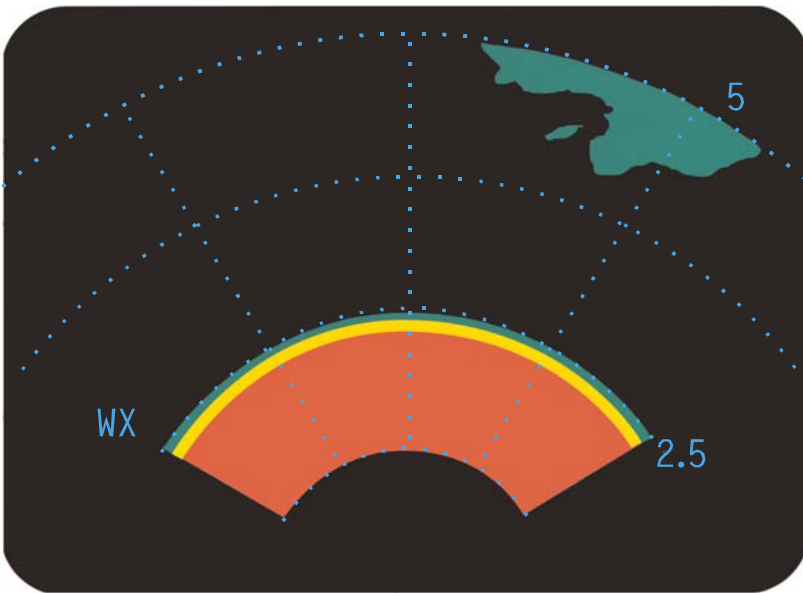

Figure 6.5.10-1. Short Range Display

In the weather mode, the RDR-1600 is unable to ascertain radar returns from close in. On the short range displays, the RDR-1600 paints a red arc in this range to depict the dead band area, as shown in Figure 6.5.10-1.

6.6 PATH PLANNING

Remember to plan a deviation path early. Simply skirting the red portion of a cell is not enough. Plan an avoidance path for all weather echoes which appear beyond 100 miles since this indicates they are quite intense.

The most intense echoes are severe thunderstorms. Remember that hail may fall several miles from the cloud, and hazardous turbulence may extend as much as 20 miles from the storm. Avoid the most intense echoes by at least 20 miles, that is, echoes should be separated by at least 40 miles before you fly between them. As echoes diminish in intensity, you can reduce the distance by which you avoid them.

6.6.1 Path Planning Considerations

- Avoid cells containing red areas by at least 20 miles.
- Do not deviate downwind unless absolutely necessary. Your chances of encountering severe turbulence and damaging hail are greatly reduced by selecting the upwind side of the storm.
- If looking for a corridor, remember corridors between two cells containing red areas should be at least 40 miles wide from the outer fringes of the radar echo.

Note

✈ Do not approach a storm cell containing red any closer than 20 nm. Echoes should be separated by at least 40 nm before attempting to fly between them.

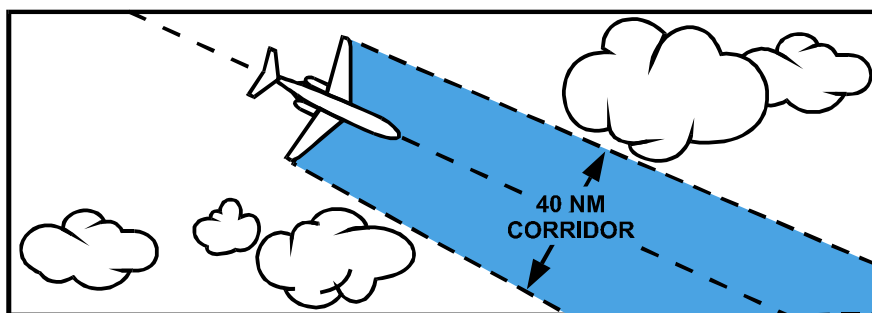

Figure 6.6.1-1. Penetration of Weather

When a complete detour is impractical, penetration of weather patterns may be required. Avoid adjacent cells by at least 20 miles.

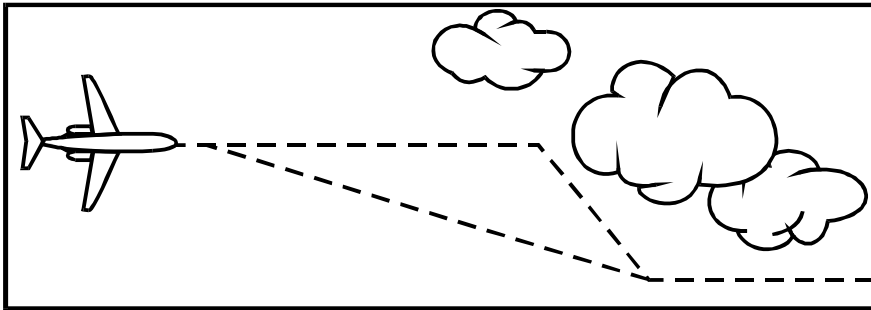

Figure 6.6.1-2. Minimizing Doglegging

Cells beyond 75 miles are areas of substantial rainfall; do not wait for red to appear. Plan and execute evasive action quickly to minimize “doglegging.”

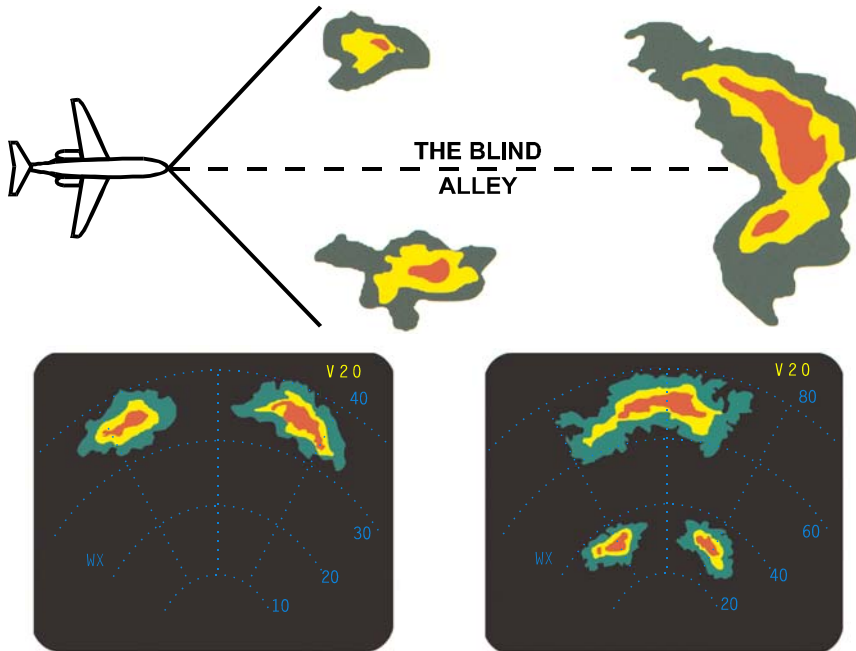

Figure 6.6.1-3. “Blind Alley” or “Box Canyon” Situations

A “Blind Alley” or “Box Canyon” situation can be very dangerous when viewing the short ranges. Periodically switch to longer range displays to observe distant conditions. As shown above, the short-range returns show an obvious corridor between two areas of heavy rainfall, but the long-range setting shows a larger area of heavy rainfall.

Above all, remember: Never regard any thunderstorm as LIGHT, even when radar observers report the echoes are of light intensity. Avoiding thunderstorms is the best policy.

DON'T attempt to preflight plan a course between closely spaced echoes.

DON'T land or take off in the face of a thunderstorm in the projected flight path. A sudden wind shift or low level turbulence could cause loss of control.

DON'T attempt to fly under a thunderstorm even if you can see through to the other side. Turbulence under the storm could be severe.

DON'T try to navigate between thunderstorms that cover 6/10 or more of the display. Fly around the storm system by a wide margin.

DON'T fly without airborne radar into a cloud mass containing scattered embedded thunderstorms. Scattered thunderstorms not embedded usually can be circumnavigated.

DO avoid by at least 20 miles any thunderstorm identified as severe or giving an intense radar echo. This is especially true under the anvil of a large cumulonimbus.

DO clear the top of a known or suspected severe thunderstorm by at least 10,000 feet altitude. This may exceed the altitude capability of the aircraft.

DO remember that vivid and frequent lightning indicates a severe thunderstorm.

DO regard as severe any thunderstorm with tops 35,000 feet or higher whether the top is visually sighted or determined by radar.

7.0 SEARCH OPERATIONS

7.1 GROUND MAPPING

A secondary objective of the radar system is gathering and presentation of terrain data. This data is represented in the form of a topographical map that can be employed as a supplement to standard navigation procedures. Target quality affects the indicator display in various situations. Use of the SRCH gain control and TILT knob will often improve picture contrast so specific ground targets are more readily recognizable.

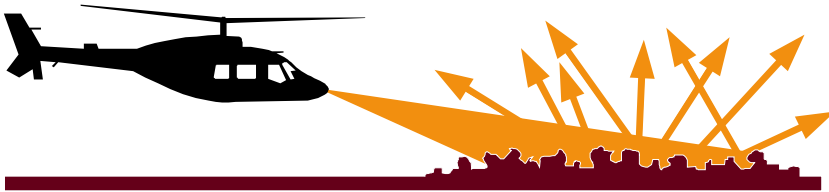

Figure 7.1-1. Over Terrain

Illumination of terrain results in a “diffused” reflection of the beam. A portion of this reflected energy is scattered back toward the antenna resulting in the prominent display of land features as well as lakes, large rivers, shore lines and ships.

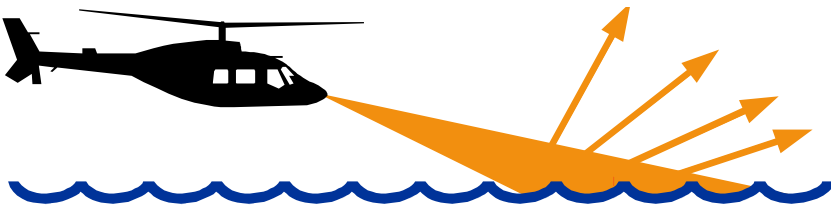

Figure 7.1-2. Over Water

Calm water or water with swells does not provide good returns. The energy is reflected in a forward scatter angle with inadequate portions being returned. The resulting display is “no target”. Choppy water provides better returns from the downwind side of the waves. The resulting display is a target whose intensity will vary with the degree to choppiness.

7.1.1 Looking Angle

The incident angle at which the terrain is illuminated has a direct bearing on the detectable range and the area of illumination. A large incident angle gives the radar system a smaller detectable range of operation (due to a minimized reflection of direct radar energy). However, the illuminated area "A" is larger.

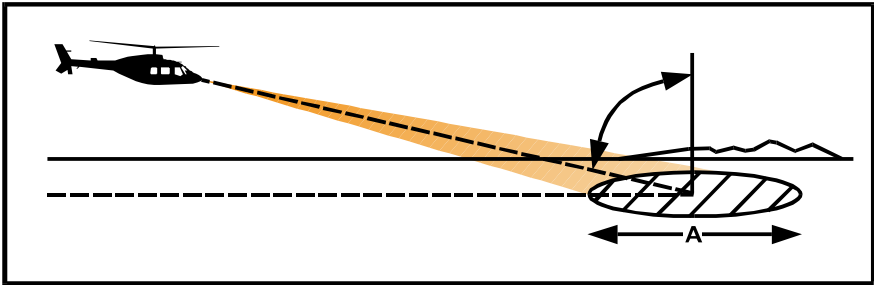

Figure 7.1.1-1. A Smaller Incident Angle

A smaller incident angle gives the radar a larger detectable range of operation because of an increase of direct radar energy reflected from the target to the antenna. The area of illumination ("A") is smaller.

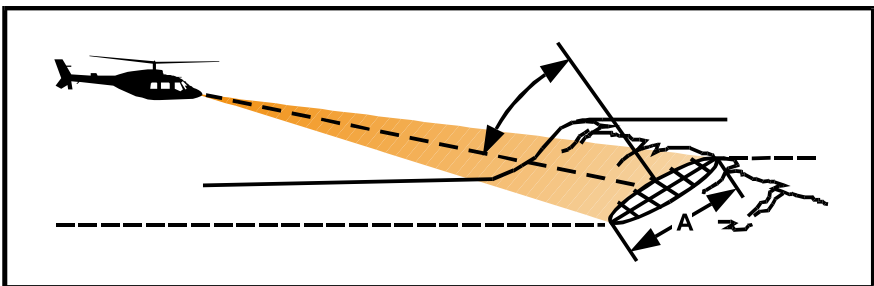

Figure 7.1.1-2. Concentration of the Beam

Concentration of the beam energy on the small area of terrain increases the magnitude of the echo intercepted by the antenna. The resulting detectable range is therefore increased for mountainous terrain; the maximum distance at which this terrain can be monitored is greater because of the more direct reflection (or radar echo) produced. Illuminating the backslope of hills stretches the area of coverage beyond the flat terrain coverage.

7.1.2 Other Aircraft

Tests show that only with extremely careful observation at relatively short ranges can other aircraft be detected by this type of radar equipment. The character of this echo is such that this type of radar system cannot be considered adequate for this purpose.

7.2 SEARCH MODE

An advantage of this radar system is the enhancement of short range mapping capability. This facilitates locating specific targets on land or sea and provides a navigational map as a supplement to standard navigation procedures.

7.3 DIFFERENCE BETWEEN WEATHER AND SEARCH MODES

In weather modes, the receiver gain is preset and cannot be changed by the pilot. In the search modes, the pilot controls receiver gain with the SRCH knob on the indicator front panel for best display resolution. Additionally, in search modes on ranges below 10 miles, the transmitter pulse is changed to enhance target resolution.

When operating in weather or search modes, both weather and ground returns can appear on the screen at the same time.



SRCH GAIN



Figure 7.3-1. Wx and SRCH Buttons

7.4 SEARCH MODES COMPARED

In the photographs below, the aircraft is flying southwest along the Florida Keys. Florida's marshy coast is on the right and the islands are in the center of the screen. Strong boat target returns are on the left. Tilt and search gain are adjusted for optimum display. Note that in SRCH 3, the land masses blend together while in SRCH 2 and SRCH 1, a small boat (arrow) target can be extracted from heavy seas.

7.4.1 Search 3

Conventional ground map mode. Beyond 10 mile range, SR1 and SR2 are the same as SR3.

The radar's long range mapping compatibility may be used to recognize known, well defined targets such as mountains, lakes, rivers, or cities. Use of gain and tilt controls will often improve picture quality.

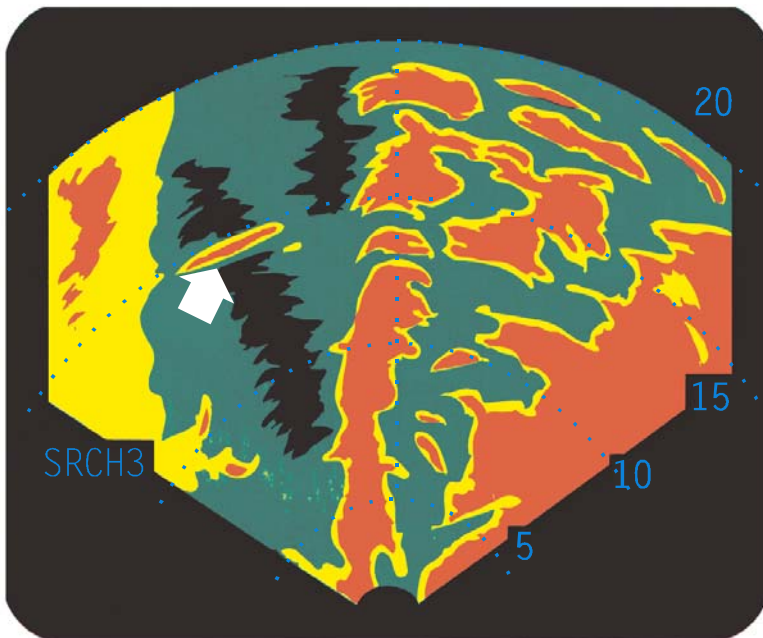

Figure 7.4.1-1. Search 3

7.4.2 Search 2

Short range precision mapping on ranges of 10 miles or less.

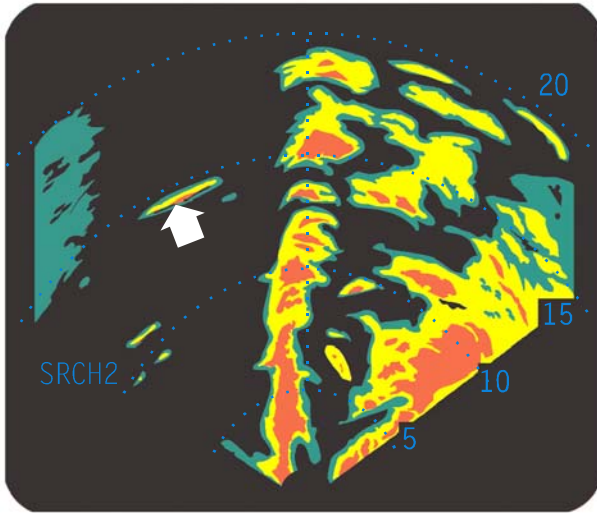

Figure 7.4.2-1. Search 2

7.4.3 Search 1

Sea clutter rejection effect on ranges of 10 miles or less.

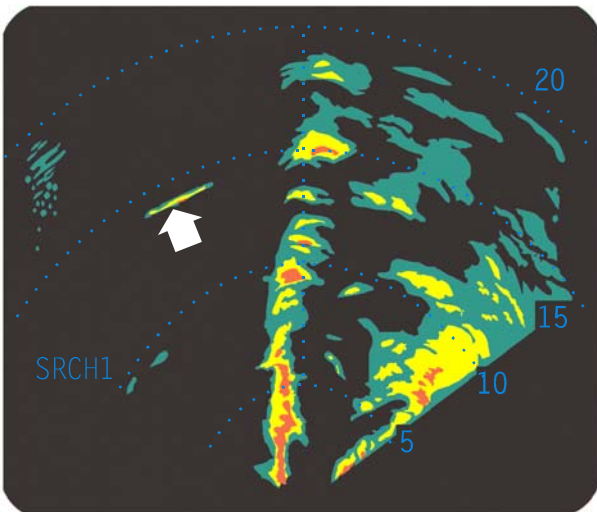

Figure 7.4.3-1. Search 1

8.0 TILT MANAGEMENT

8.1 TILT CONTROL

One of the most important factors in improving your expertise in using your radar is antenna tilt management. Control of the vertical movement of the antenna, and hence the radar beam, is through the antenna tilt knob. Proper antenna tilt management provides information of the storm's approximate size and relative direction of movement.

The correct procedure for weather avoidance is to aim the antenna directly at the storm, not above it, or at the ground. The tilt control permits positioning the antenna in small increments up or down, to keep the antenna intersecting the storm area. Also, changes in pitch attitude can be compensated for by adjusting the antenna tilt.

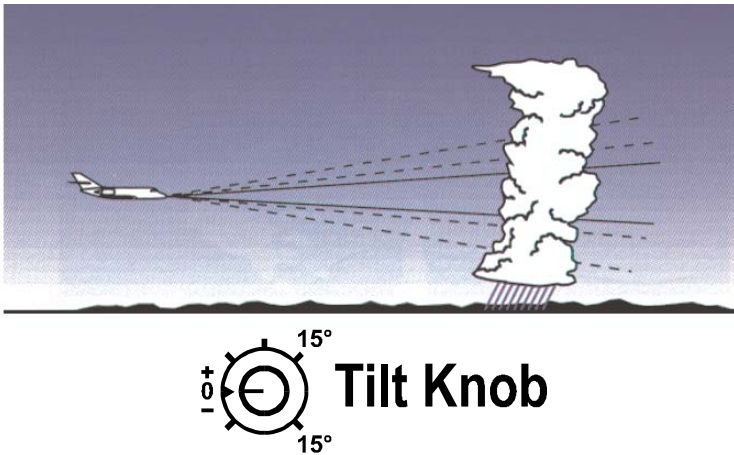

29247

Figure 8.1-1. Adjusting the Antenna Tilt

8.2 TILT PERFORMANCE CHECK

A good performance check of your radar system in flight is to lower the tilt slowly and observe the maximum range of solid ground returns. As a rule of thumb, this range in miles should approximate the square root of your operational altitude.

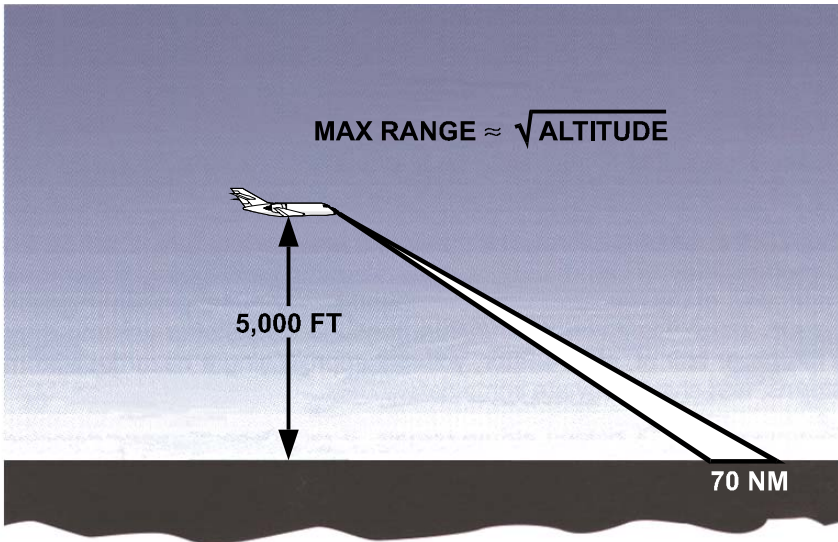

Figure 8.2-1. Altitude vs. Range

For example, at 5,000 ft. the maximum displayed ground target range should be about 70 nautical miles. You should perform this test on every flight. Don't wait until you're penetrating severe weather to discover that your system is not providing optimum performance.

If the radar is operating normally when you reach cruising altitude, select the longest display range and lower the antenna tilt until ground targets are displayed. Now, slowly raise the tilt until the ground returns disappear. This will give you the optimum tilt setting for your cruise altitude. Each time a new range is selected, however, the tilt control must be readjusted, down for a shorter range, and up for a longer one.

8.3 EARLY DETECTION OF ENROUTE WEATHER

To set the Antenna Tilt to optimize the radar's ability to quickly identify significant weather, follow these steps:

1. Select the Wx (Weather) or WxA (Weather Alert) mode of operation. Adjust brightness control as desired.
2. Select the 40 or 80 nm range.
3. Adjust the Antenna Tilt control down until the entire display is filled with ground returns.
4. Slowly work the Antenna Tilt up so that ground returns are painted on or about the outer one third of the indicator area.
5. Watch the strongest returns seen on the display. If, as they are approached, they become weaker and fade out after working back inside the near limit of the general ground return pattern, they are probably ground returns or insignificant weather. If they continue strong after working down into the lower half of the indicator, you are approaching a hazardous storm or storms, and should deviate immediately.
6. Examine the area behind strong targets. If radar shadows are detected, you are approaching a hazardous storm or storms, and should deviate immediately. Regardless of the aircraft's altitude, if weather is being detected, move the Antenna Tilt control up and down in small increments until the return object is optimized. At that angle, the most active vertical level of the storm is being displayed.

Note

The TILT position in Step 4 should be that shown in the chart. The exact setting will depend upon the aircraft's pitch altitude and the flatness of the terrain.

Table 8.3-1. Antenna Tilt Control Settings

Altitude (ft)	Antenna Tilt Angle			Line-of-Sight Range (SM)
	10"	12"	18"	
5,000	+7.0°	+6.0°	+5.0°	87
10,000	6.0°	5.0°	4.0°	123
15,000	5.5°	4.0°	3.0°	150
20,000	4.5°	3.5°	2.5°	174
25,000	4.0°	3.0°	2.0°	194
30,000	3.5°	2.5°	1.5°	213
35,000	3.0°	2.0°	1.0°	230
40,000	2.5°	1.5°	0.5°	246

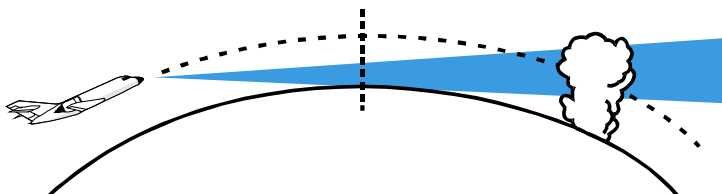

Figure 8.3-1. Weather Target

If target is shown at or beyond the line-of-sight range listed above, the chances are good that it is a weather target.

9.0 ANTENNA STABILIZATION

Airborne radar antennas are stabilized to preserve a normal cockpit display when the aircraft is climbing, descending or turning. When the aircraft departs from straight and level flight, the stabilization system automatically adjusts the antenna position to compensate for the change. Both limits and errors associated with antenna stabilization are important to the pilot.

9.1 LIMITS

The limits of antenna stabilization are different for climbing or descending and turning while climbing or descending. For straight ahead climbs and descents, the limits are simply the mechanical stops at 30 degrees. When turning, the tilt and bank angles determine the stabilization limits (the rule of thumb is a total of 30 degrees) so moderate turns combined with moderate climbs and descents will stay within limits.

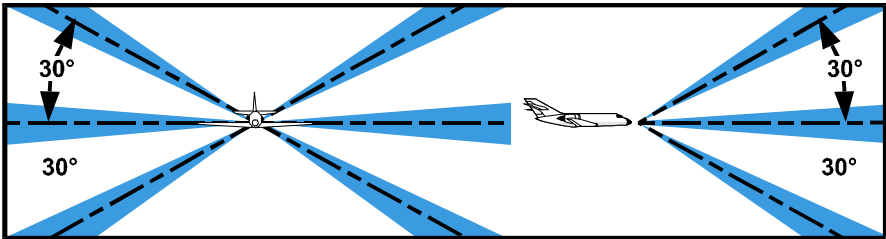

Figure 9.1-1. Aircraft Pitching/Rolling $\pm 30^\circ$

9.2 ERRORS

There are two sources of stabilization errors: acceleration and drift. Accelerations and decelerations cause the gyro to precess in pitch. The pilot may not notice a small temporary discrepancy between the altitude indicator and visible horizon, but on the radar screen the antenna pitch precession will appear as an exaggeration of the desired tilt. Drift errors (appearing on the attitude indicators pitch and roll precession accumulate in turns) disappear slowly after the aircraft returns to straight and level. Gyro precession errors directly affect radar stabilization and the quality of the return displayed on the screen.

9.3 COMPENSATION

There are some compensations the pilot can use for antenna stabilization errors. When the system has been operating properly in level flight, the pilot may be able to correct for ground return showing on one side and not the other by tilting the antenna up until all ground returns are cleared. During takeoff, the pilot can raise the antenna tilt to clear the ground returns caused by gyro acceleration error, then as the airplane stops accelerating, readjust the antenna tilt back toward level. Adjusting antenna tilt is also the remedy for ground returns that appear because of gyro precession in a prolonged turn. Good operating practices include:

- Adjust radar and obtain weather picture before takeoff
- Compensate antenna tilt for gyro precession
- Evaluate weather in the immediate sphere of operation
- Do not “over-scan” weather targets
- During excessive aircraft maneuvers, recognize the limitations of stabilization

10.0 BEACON MODES

In the Beacon (BCN) mode, the RDR-1600 can interrogate, receive and display signals from fixed transponder beacons on all ranges. The beacon itself is displayed as curved “slashes”, with the position of the beacon located approximately in the center of the closest slash.

The RDR-1600 will also display the bearing and radar distance to any selected beacon; this information is displayed in the lower left corner of the indicator display.

For greater flexibility, the beacon mode may be operated alone or in combination with the weather or search modes.

10.1 BEACON FORMAT SELECTION

The RDR-1600 will always display all beacon signals on the screen as they respond to the radar interrogation, regardless of the format selection.

To identify a particular beacon and place an identification number beside it, you must first identify whether the beacon is the standard or DO-172 format. This is accomplished by observing the beacon responses.

If the beacon is of the standard format, there will always be only 2 “slashes” on the display spaced 7 nm apart or more. The RDR-1600 can identify any one of nine standard beacons in this mode.

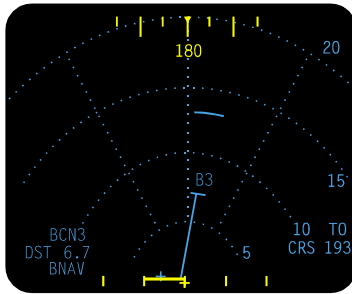

Figure 10.1-1. Standard Beacon

10.2 DO-172

A selected beacon utilizing the DO-172 format will have two framing “slashes” which are positioned approximately 2 nm apart. Within these two “frames” will be a combination of up to four slashes. Varying the combinations of the inner slashes makes it possible to identify any one of fifteen different DO-172 beacon codes. This feature is especially beneficial when operating in areas of multiple beacon activity.

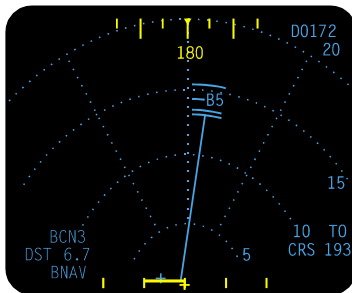

Figure 10.2-1. DO-172

After the beacon type has been identified and the proper format selected, the operator may now select the desired beacon number by pressing the COURSE/CODE (CRS CODE) button the proper number of times.

11.0 AC 90-80

The FAA allows lower minimums in radar approaches to clusters of rigs, when both the radar altimeter and “course bearing cursor” are operating and are used as described in AC 90-80. For details on minimum approach heights and distances, refer to FAA AC 90-80.

Note

- ✉ Advisory Circular AC 90-80, Approval of Offshore Standard Approach Procedures. . . can be downloaded from www.faa.gov in Adobe Acrobat format.

Click on:

- Aviation Support and Regulation, then
- Guidance, Reference, Advisory, then
- Index of FAA Advisory Circulars (AC)

Go to the search engine at the bottom of the AC page and enter the title in quotations to find the AC.

12.0 MULTIPLE INDICATORS

An additional MFD unit, is required for multiple indicator installations.

Since all controls for the radar system are located on the control panel, both MFD observers will see the same display.

- Operating modes
- Search and beacon gain
- Antenna tilt angle
- Antenna scan angle
- Beacon code

All indicators independently control:

- Display range
- Desired brightness level

The RDR-1600 will perform dual scan operation when the range of indicator No. 1 (or 2) is greater than or equal to 20 nm and indicator No. 2 (or 1) is less than or equal to 10 nm, and the mode of operation is either search 1 or search 2. In this situation, the short range will use a short transmitted pulse, and the long range will use a long transmitted pulse. This is an incompatible situation in that the transmitter cannot transmit both a long and short pulse at the same time. In this situation, indicator No. 1 will be updated on the right to left sweep of the antenna, and indicator No. 2 will be updated on the left to right sweep of the antenna.

13.0 SYSTEM SPECIFICATIONS

13.1 RT-1601 RT UNIT

Frequency: 9375 MHz Xmit/Rec; 9310 MHz BCN REC

RF Power Output: 10 KW Peak Power

PRF/Pulse Width: Short Range Search 1500 P.P.S./0.2 sec

Long Range Search and Beacon; 200 P.P.S./2.35 sec

Altitude: 50,000 ft.

Temperature: -50°C to +55°C

Size: 5"w x 6-1/4"h x 13-7/8"d (1/2 ATRI)

Weight: 16 lbs. (7.26 kg)

TSO: C63c

13.2 DA-1203A ANTENNA DRIVE ASSEMBLY

Reflector Size: 10", 12", or 18" Flat Plate

Scan Angle: 120° or 60°

Tilt Angle: ±15°

Scan Rate: 28°/sec

Stabilization Accuracy: ±1°

Altitude: 50,000 ft.

Temperature: -50°C to +55°C

Weight: 10", 0.88 lbs. (4 Kgs), 12"; 1.1 lbs. (0.498 Kgs), 18"; 2.2 lbs. (1.0 Kgs)

Drive Assembly: 6.5 lbs. (2.95 Kgs)

Counterbalanced Drive Assembly: 9.5 lbs. (4.32 Kgs)

TSO: C63b

13.3 CP-113K CONTROL PANEL

Environmental Qualification:	DO-160A Env. Cat. F1A/PKS/XXXXXXABABA
Altitude:	55,000 feet
Temperature:	-20 degrees C. to +55 degrees C. (-4 degrees F. to +131 degrees F.)
Cooling:	May be required as determined by ambient temperature range in aircraft cockpit.
Mounting:	Panel mounted, DZUS.
Weight:	1.7 lbs. maximum (0.77 kg)
TSO:	C63c

Overall Dimensions

Height:	2.25 inches maximum (57.2 mm)
Width:	5.75 inches maximum (146.0 mm)
Length:	6.5 inches maximum (165.1 mm)

Input Power

Voltage	+28 Vdc inputs per DO-160A Category B. Two inputs available.
Power Draw Using +28 Vdc Lighting Power Bus	2.5 watts maximum electrical power drain from +28 Vdc power bus plus 7.5 watts maximum lighting power drain from +28 Vdc lighting bus.
Power Draw using 5 Vac, 400 Hz Lighting Power Bus	10 watts maximum electrical and lighting input power drain from +28 Vdc power bus. One milliamp power drain from 5 Vac lighting bus (reference).

Copyright 2001
Telephonics
TM106101(10/04)



Command Systems Division
815 Broad Hollow Road, Farmingdale, NY 11735
Phone: 1 (631) 755-7004 • Fax: 1 (631) 755-7227
www.telephonics.com